

USER MANUAL**FOOD WASTE DISPOSER 500A-MC EXCELLENT SERIES
FOR FREE-STANDING INSTALLATION**

Product Description Installation Safety Operation Service

DISPERATOR AB

Mälärvägen 9, SE-141 71 Segeltorp, Sweden

Tel: +46 8 724 0160, Fax: +46 8 724 6070

info@disperator.se, www.disperator.se

Dok. ref: User manual 500A-MC Rev. B

EC DECLARATION OF CONFORMITY

We, the manufacturer **Disperator AB**
Mälärvägen 9
SE-141 71 SEGELTORP
Sweden
Phone: +46 8 724 0160
Fax: +46 8 724 6070
E-mail: info@disperator.se

hereby declare under our sole responsibility that the machinery,

Description: **Disperator Food Waste Disposer**
Model / type: **510A-MC, 515A-MC, 520A-MC, 530A-MC, 550A-MC & 575A-MC**
Place of origin: **Segeltorp, Sweden**

to which this EC Declaration relates, fulfills all the relevant provisions of the Machinery Directive 2006/42/EC, Low voltage Directive 2006/95/EC, and the EMC Directive 2004/108/EC.

The following harmonized standards have been used

SS-EN ISO 12100:2010
SS-EN ISO 13857:2008
SS-EN 953+A1:2009
EN 60204-1
EN 61000-6-1
EN 61000-6-2
EN 61000-6-3
EN 61000-6-4

This declaration relates exclusively to the machinery in the state in which it was placed on the market, and excludes components which are added and/or operations carried out subsequently by the end user.

Authorized to compile the technical file is Tomas Martinsson, Disperator AB.

Segeltorp, 2014-08-26
Disperator AB



Lars Holmqvist
Managing Director

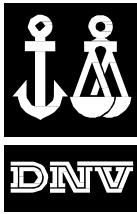

SKM-13-0060

DET NORSKE VERITAS

DECLARATION OF COMPLIANCE

This is to declare that the food waste disposer equipment for installation as garbage handling equipment on ships and floating platforms, DISPERATOR models 510, 515, 520, 530, 550 & 575 manufactured by Disperator AB are in compliance with applicable sections of MARPOL consolidated edition 2011/2012, ANNEX V REGULATIONS FOR THE CONTROL OF POLLUTION BY GARBAGE FROM SHIPS.

Regulation 4

Discharge of garbage outside special areas

1 Subject to the provisions of regulations 5, 6, and 7 of this Annex, discharge of the following garbage into the sea outside special areas shall only be permitted while the ship is en route and as far as practicable from the nearest land, but in any case not less than:

- .1 3 nautical miles from the nearest land for food wastes which have been passed through a comminuter or grinder. Such comminuted or ground food wastes shall be capable of passing through a screen with openings no greater than 25 mm.

Regulation 5

Special requirements for discharge of garbage from fixed or floating platforms

2 Food wastes may be discharged into the sea from fixed or floating platforms located more than 12 nautical miles from the nearest land and from all other ships when alongside or within 500 m of such platforms, but only when the wastes have been passed through a comminuter or grinder. Such comminuted or ground food wastes shall be capable of passing through a screen with openings no greater than 25 mm.

Regulation 6

Discharge of garbage within special areas

1 Discharge of the following garbage into the sea within special areas shall only be permitted while the ship is en route and as follows:

- .1 Discharge into the sea of food wastes as far as practicable from the nearest land, but not less than 12 nautical miles from the nearest land or the nearest ice shelf. Food wastes shall be comminuted or ground and shall be capable of passing through a screen with openings no greater than 25 mm. Food wastes shall not be contaminated by any other garbage type.

For Det Norske Veritas AB

Anna Berglund
Senior Surveyor



Digitally Signed By: Berglund, Anna

Location: DNV Stockholm

Signing Date: 2013-06-11

If any person suffers loss or damage which is proved to have been caused by any negligent act or omission of Det Norske Veritas, then Det Norske Veritas shall pay compensation to such person for his proved direct loss or damage. However, the compensation shall not exceed an amount equal to ten times the fee charged for the service in question, provided that the maximum compensation shall never exceed USD 2 million. In this provision "Det Norske Veritas" shall mean the Foundation Det Norske Veritas as well as all its subsidiaries, directors, officers, employees, agents and any other acting on behalf of Det Norske Veritas.

Index

1. Safety Precautions.....	7
1.1. Safety Signs.....	7
1.2. Personnel Qualifications and Training.....	8
2. Company Profile	9
3. Product Description and Technical Specification	9
3.1. Food Waste Disposer 500A-MC EXCELLENT SERIES for Free-standing Installation	9
3.2. Technical Specification	10
4. Storage and Transport.....	11
4.1. Storage	11
4.2. Transport	11
5. Included in Delivery.....	12
5.1. Documentation.....	12
5.2. Disposer.....	12
6. Installation Instructions.....	14
6.1. Installation of Disposer.....	14
6.1.1. Fixating of Disposer	14
6.1.2. Changing Position of the Disposer Outlet	15
6.2. Flushing Water	16
6.2.1. Water Pipe ½".....	16
6.2.2. Line Strainer and Solenoid Valve ½".....	16
6.2.3. Reinforced Flexible Hose ½" for Flushing Water.....	16
6.2.4. Vacuum Valve (back flow preventer)½"	16
6.3. Water Trap and Drain Pipe	17
6.3.1. Dimensions	17
6.3.2. Depth and Threshold of Water Trap	17
6.3.3. Curves and Bends	17
6.3.4. Level Difference.....	17
6.3.5. Slope of Drain Pipe	17
6.3.6. Vacuum Evacuation	17

6.4.	Electrical Connection.....	18
6.4.1.	Supply Voltage.....	18
6.4.2.	Mains Fuses	18
6.4.3.	Main Electrical Safety Switch	18
6.4.4.	Cable Dimension.....	18
6.4.5.	Cable Protection	18
6.4.6.	Earth Wire and Ground Fault Circuit Breaker	18
6.4.7.	Direction of Rotation for the Disposer	18
6.4.1.	Safety Interlock Switch	18
6.5.	Start Up and Final Testing	19
6.5.1.	Grinder Check.....	19
6.5.2.	Checks before Start Up.....	19
6.5.3.	Final Mesures	19
7.	Wiring diagram	19
8.	Safety Instructions.....	20
9.	Operating Instructions.....	20
9.1.	Start and Stop.....	20
9.2.	Daily Cleaning	20
9.3.	Trouble Shooting	21
9.3.1.	Disposer Reduces Speed, stops or does not start	21
9.3.2.	The Disposer starts but there is no Flushing Water	21
9.3.3.	The Disposer does not start and makes no Sound.....	21
10.	Service Instructions	22
10.1.	Authority.....	22
10.2.	Exploded view of the Disposer	22
10.3.	Maintenance and Service of Assembly and Cabinet	23
10.4.	Dismantling of Disposer.....	23
10.5.	Assembly of Disposer	25
10.6.	Service and Maintenance Intervalls	27
10.7.	Spare Parts.....	28
10.7.1.	Service Packs	28
10.7.2.	Identification Guide for 500A EXCELLENT SERIES Spare Parts	29

1. Safety Precautions





This manual contains basic instructions which must be observed when installing, operating and servicing the disposer. It is therefore essential for the installer, user or responsible technician to read the manual thoroughly prior to installation and operation.

A copy of the manual must always be at hand where the disposer is being used.

In addition to the general safety instructions listed in this main section, it is necessary to observe the special safety rules included in other sections of the manual.

1.1. Safety Signs

The following safety signs are used in this manual and on the disposer. Failure to comply with safety precautions may cause personal injury or damage the disposer.

Read the User Manual before use	
Risk of electric shock	
Danger to general public	
Risk of mutilation (rotating parts)	

Warning plates located on or close to the disposer must always be observed and kept legible.

1.2. Personnel Qualifications and Training

All personnel operating, performing maintenance, inspecting or installing the disposer must be properly trained and qualified. Areas of responsibility, scope of authority and staff supervision must be defined by the owner. If personnel do not have the necessary qualifications, they must receive training and instructions. Training can be provided by the supplier/manufacturer. It is the responsibility of the owner of the disposer to make sure that all users read and understand this User Manual.

Transportation

Personnel responsible for transporting the disposer must be familiar with accident prevention regulations for any hoisting gear and lifting accessories to be used. Handlers should be given appropriate instructions prior to undertaking transportation, hoisting and lifting.

Installation

Personnel responsible for installing the disposer must be trained as an industrial mechanic/technician. The electric connection must be performed by trained and certified electricians.

Start-up and Maintenance

Personnel responsible for start-up and maintenance of the disposer must be familiar with its design and functions. They must understand the operating principle of the disposer and have read the manual and the safety instructions before commencing work.

Operation

All persons who operate the disposer must be aware of the risks associated with the operation of the disposer, which are described in this manual.

Service and Repair

Personnel responsible for service and repair of the disposer must have training as, or equivalent to, industrial mechanics/technicians. They must also have knowledge of, and be aware of, the specific details of the disposer, as described in this manual. Unskilled personnel must be trained and any repair work undertaken must be checked by the owner.

2. Company Profile

Disperator's business idea is to provide innovative and adaptable waste disposal equipment for kitchens on land as well as at sea, and for the food industry. Our disposers produce finely ground food waste which can be anaerobically digested and is also suitable for composting, which is of use to society.

With over 60 years of experience in the field of production and development, our dedication has resulted in the unique dependability which is needed within the marine industry. Furthermore, our innovativeness has provided commercial kitchens on land with an alternative approach to handle food waste separation at source, complying with modern demands and being economically reasonable.

Our assortment is unique! Disperator is the only manufacturer that offers all types of installation possibilities in a kitchen. Our basic range consists of six different sizes of waste disposers, which may be combined with 12 different mounting assemblies. Further, the advantage of the basic model's design, is that the waste disposers may easily be integrated into other manufacturer's mounting assembly or furnishings without difficulty. Thereby, designing each workplace in a kitchen or galley to its specific requirements regarding function, ergonomics and economy.

3. Product Description and Technical Specification

3.1. Food Waste Disposer 500A-MC EXCELLENT SERIES for Free-standing

Installation

Disperator food waste disposers are used in kitchens and galleys around the world, providing an efficient and immediate removal of food waste whenever the need arises and thereby improving hygiene in the working environment, eliminating bad odors and bacteria formation and minimizing manual handling.

Our product range is designed with the user's needs in focus and meets today's requirements for handling of food waste. The high quality grinder of specially alloyed steel together with the unique and well-proven sealing design between the grinder and motor provides the user with many years of operational reliability and low maintenance cost. The disposer's life span is extended further by the outer housing of stainless steel EN 1.4301 (AISI 304) and protection class IP55 for electrical components as standard.

The MC cabinet with integrated food waste disposer is installed as a separate unit, eliminating mounting into existing interior, and is delivered ready to be connected to existing flushing water, drain pipe and electricity. If needed, it is possible to adjust the disposer's outlet to better fit the existing drain piping.

The wide range of disposer sizes makes it easy to adjust any installation to fit any workplace in a galley or kitchen. The MC cabinet permits continuous feeding of waste into the disposer and the inlet is partly covered by a labyrinth protection guard preventing accidental access to the grinding unit during operation. The guard is fitted with a safety interlock switch which stops the disposer when lifted. The cabinet is delivered with a flushing nozzle or flushing towers, solenoid valve and line strainer already assembled for easy installation. Cold water will automatically flow when the disposer starts and flush the food waste into the grinder chamber and continue into the sewer system or connected tank.

Food waste disposers within the Disperator Excellent Series have the Declaration of Compliance issued by DNV, verifying compliance with applicable sections of MARPOL consolidated edition 2011/2012 ANNEX V for disposal of ground food waste into the open sea.

3.2. Technical Specification

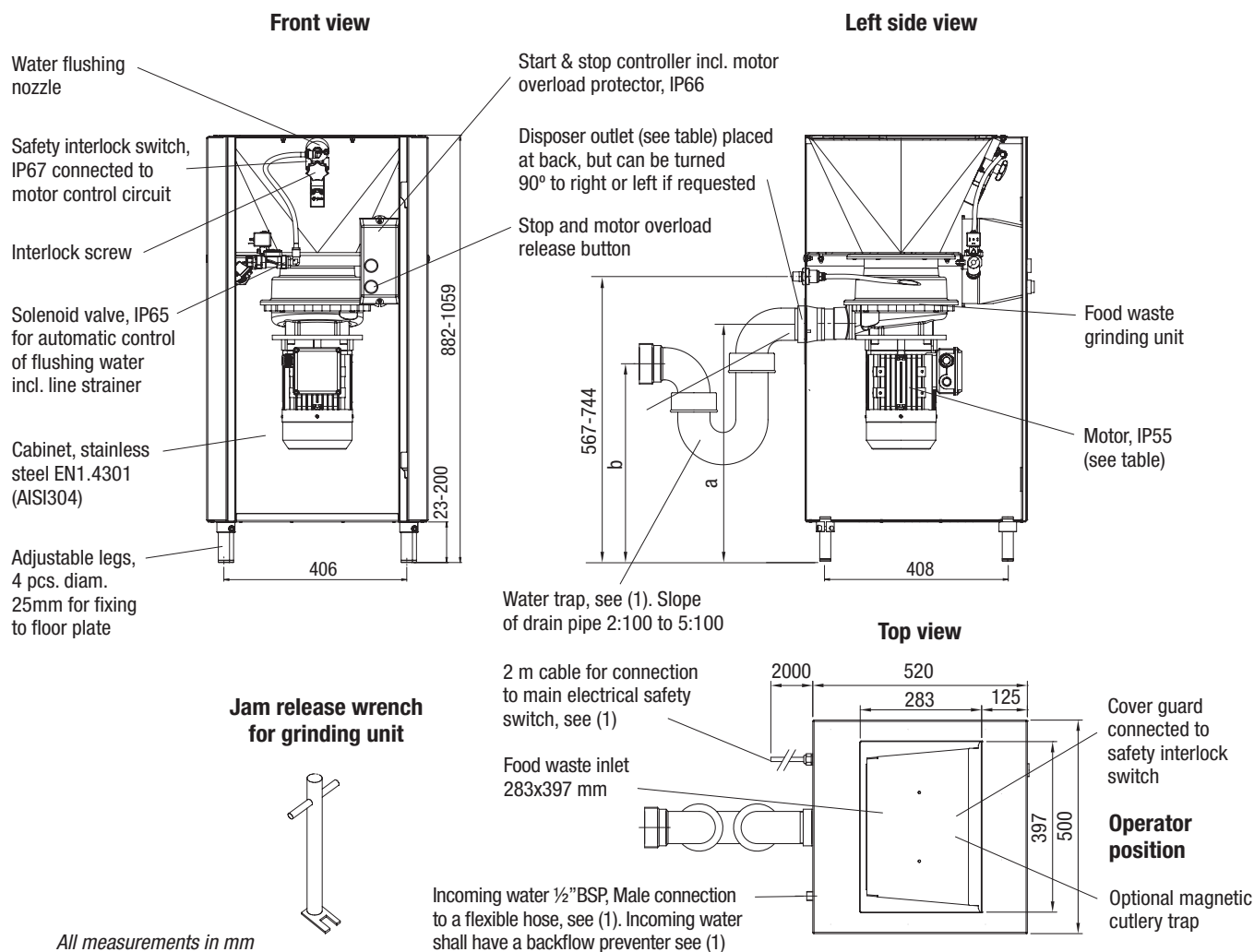

Technical specification	510A	515A	520A	530A	550A	575A
Normal capacity, kg/hr.	300	400	500	700	850	1000
Electrical power, kW	0,75	1,1	1,5	2,2	4,0	5,5
Rated current, A for:						
400V / 3 ph. / 50 Hz	2,1	2,6	3,6	5,2	8,6	11,5
440V / 3 ph. / 60 Hz	2,1	2,4	3,5	5,0	7,5	10,0
480V / 3 ph. / 60 Hz	1,9	2,6	3,5	4,6	7,2	9,6
Other 3-ph voltages available	1-ph 220-240V, 50/60Hz also available for models 510 and 515.					
Control voltage	For marine installation the same as motor voltage. For land installation 230V/50Hz.					
Fuse rating, slow	10A	10A	10A	16A	16A	16A
Drainage outlet	2"	BSP	Female	2 ½"	BSP	Female
Height of disposer (a)	a=519-696				a=484-661	
Ditto for water trap (b)	b=467-644				b=452-629	
(If ordered from Disperator)						
Gross / net weight, kg	64 / 55	65 / 56	69 / 60	83 / 74	86 / 77	92 / 83
The Disposer works in the temperature range -5°C - +40°C						

(1) Installation material needed but not incl. in standard delivery are:

- main electrical safety switch,
- flexible hose R½" for cold flush water,
- backflow preventer for flush water,
- water trap for connection to disperator outlet.

Can be ordered from DISPERATOR.

(2) User manual with installation and service instructions,

- wiring diagram, laminated operating instructions and laminated safety instructions included in delivery.

4. Storage and Transport

4.1. Storage

If the disposer is to be stored before the installation, it should be handled as follows:

- Store the disposer in a dry and clean area where the relative humidity does not exceed 60%.
- Storage temperature should be minimum -20°C and maximum +60°C.

4.2. Transport

The disposer must not be handled manually. It is recommended to use a trolley when moving the disposer.

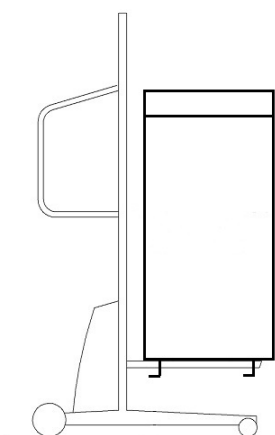



5. Included in Delivery

5.1. Documentation

- This User Manual.
- Wiring diagram, bill of material and component layout.
- Safety instructions (laminated).
- Operating instructions (laminated).

5.2. Disposer

<p>Cabinet with integrated food waste disposer with motor size and voltage according to the delivery note</p>	
<p>Start/stop unit including contactor with motor overload protector. Control voltage according to the delivery note</p>	
<p>Complete solenoid valve ½" BSP, Female including cable plug and coil with control voltage according to the delivery note. Premounted in the cabinet.</p>	

<p>Line strainer ½" BSP, Female. Premonted in the cabinet.</p>	
<p>Jam release wrench for freeing rotary grinder if non-grindable object gets jammed</p>	
<p>4pcs of adjustable legs</p>	

6. Installation Instructions

6.1. Installation of Disposer

If not otherwise requested, the cabinet is delivered without the legs mounted. All legs (4pcs) are delivered inside the cabinet and should be mounted as the first step of assembly. Two persons should be present when the legs are mounted to minimize the risk of injuries.

If a trolley with lifting plate (or other lifting gear) is available at the installation site make sure that the lifting trolley/hoist is approved for the cabinet's weight, see section 3.2 in this manual.

Proceed as follows when mounting legs:

Alternative 1

Move the cabinet to the edge of the pallet so that the first pair of leg fixing clamps will be just outside the pallet. Fixate the first pair of legs in their clamps. The cabinet is 882mm high without legs, so 18mm of the legs should extend out of the clamp to adapt the total cabinet height to kitchen standard, 900mm.

Place a pallet truck between this first pair of legs, and move the cabinet from pallet to pallet truck. Assemble the second pair of legs.

Place the cabinet on the floor and check with a spirit level on the cabinet top plate that it is in level. Adjust the legs if necessary.

Alternative 2

Open the cabinet door, and with the lift plate under the motor lift the cabinet from the pallet so that the four legs can be mounted. The cabinet is 882mm high without legs, so 18mm of the leg should extend out of the clamp to adapt the total cabinet height to kitchen standard, 900mm. Use the trolley to move the cabinet to its final installation location.

Alternative 3

If lifting devices are not available at the installation site.

Move the pallet with the cabinet as close to final installation location as possible. Move the cabinet to the edge of the pallet so that the first pair of leg fixing clamps will be just outside the pallet. Fixate the first pair of legs in their clamps. The cabinet is 882mm high without legs, so 18mm of the leg should extend out of the clamp to adapt the total cabinet height to kitchen standard, 900mm.

Tilt the cabinet slightly so that it stands on the two mounted legs, push pallet away from the cabinet and position a sturdy wooden block under the cabinet's bottom plate so that it is in level (check with a spirit level). Fixate the remaining two legs. Wiggle and slide the cabinet slowly and carefully to its final installation location.

Tighten the leg clamps using a torque of 17Nm. As this is a critical matter, a torque wrench should be used. If no torque wrench is available use a lever of approximately 30cm and a force of 6kg

6.1.1. Fixating of Disposer

The cabinet in which the disposer is assembled must be fixed to the wall/bulkhead or floor/floor plate. When starting or stopping quickly (e.g. if cutlery mistakenly jams the grinding unit) the torque of the motor will cause the disposer to turn. This may move the drain pipe/water trap from its position causing water leakage. Torque protection can be ordered from Disperator as an optional accessory

6.1.2. Changing Position of the Disposer Outlet

If not otherwise requested, the cabinet is delivered with the disposer outlet on the back of the cabinet. Considering the positioning of the cabinet in relation to the drain connection in floor / floor plate, it is possible to turn the disposer with outlet 90° to the left or to the right. If necessary please proceed in the following manner:

Open the cabinet's front door. Remove the door if needed.

Use a trolley to avoid injury when detaching the disposer from the discharge cone.

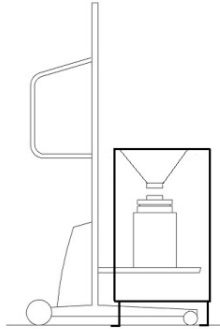

Remove the six nuts which hold the disposer to the flange of the discharge cone. Remove the hood by loosening 4 nuts. Turn the hood one step clockwise. Remount the hood. The torque should be 9,5Nm for models 510A-520A and 21Nm for models 530A-575A. Turn the disposer with outlet to the desired left or right hand position.

Make sure that the seal between the disposer and the flange of the discharge cone is in position before bolting together. Tighten the six nuts evenly.

Punch a hole in the side panel to allow connection of the outlet pipe to the disposer in the new position. On the outer cabinet's left and right hand sides two small marks can be found. Use the top mark for models with a motor power under 2,2kW or the lower mark for models with a motor power of 2,2kW or more in order to center this new panel hole for the disposer drain pipe. For models with a motor power under 2,2KW the diameter of the hole should be 63-65mm. For models with a motor power of 2,2KW or more the diameter of the hole should be 73-76mm.



The original hole for the outlet pipe should be covered by a stainless steel plate screwed to the back panel. This plate can be supplied by Disperator as an optional extra.

6.2. Flushing Water

Connection of the flushing cold water to the delivered disposer must be done by an authorized installer of water supply and in accordance to valid local regulations.

6.2.1. Water Pipe ½"

In order to allow a free flow of water to the disposer, the incoming water pipe (incl. accessories in the piping system such as vacuum valve, cut-off valve etc.) must have the same dimension as the connection to the disposer assembly, i.e. at least ½" through-out. No throttling may exist up to the solenoid valve.

6.2.2. Line Strainer and Solenoid Valve ½"

The line strainer ½" must be mounted before the solenoid valve ½" in the flow direction on the cold flushing water feed. Make also sure that the line strainer and the valve are mounted in the correct flow direction (see arrow on these components), and that the nut on the strainer (to be opened when cleaning the strainer) is directed downwards.

6.2.3. Reinforced Flexible Hose ½" for Flushing Water

As shown in figure below, a reinforced flexible hose ½" must be fitted between the incoming water pipe mounted on the wall/bulkhead, and the connection for flushing water on the disposer assembly. The hose absorbs the compressive push in the pipe when the flushing water is turned on, and absorbs any small vibrations which may occur during the grinding process of the disposer. The hose is not included in standard delivery but is available as an option from Disperator.

6.2.4. Vacuum Valve (back flow preventer) ½"

When a flushing nozzle is fitted in a sink/washing line or other type of assembly, a vacuum valve must be installed at the top of a lyre-shaped incoming water pipe, as shown in figure below. This protects the water pipe from re-suction during a possible overflow. The vacuum valve is not included in standard delivery but is available as an option. If a flush tower with air gap to sink/washing line, or other type of assembly, is fitted, no vacuum valve is needed (if not stated for other reasons and/or specified in national/local regulations).

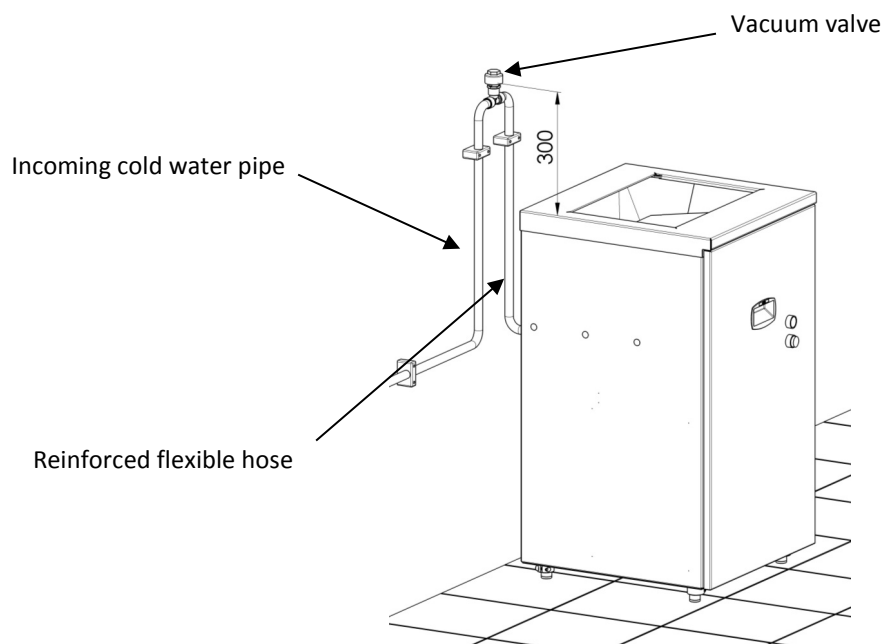

The picture above shows the positioning of a vacuum valve above a MC cabinet.

6.3. Water Trap and Drain Pipe

The drain connection of the delivered disposer must be done by an authorized installer of sewer supply and in accordance to valid local regulations. The water trap is not included in standard delivery but is available as an option.

6.3.1. Dimensions

The water trap and the drain pipe must have the same dimensions as the outlet flange of the disposer (i.e. 2" for models 510A-520A and 2½" for models 530A-575A), in order to allow free waste water flow from the disposer. No throttling in the water trap and drain pipe may exist. Larger dimensions must also be avoided as this will reduce the speed of the waste water flowing from the disposer.

6.3.2. Depth and Threshold of Water Trap

The depth of the water trap (measurement "d" in figure below) must be as small as possible in order to obtain the best possible flow with the largest amounts of food waste. The water trap must also be deep enough, so that the water threshold "d1" is approximately 80mm for models 510A–520A and 160mm for models 530A-575A.

6.3.3. Curves and Bends

The water trap, and all bends in the drain pipe, must be drawn without sharp bends or curves, according to local standards. The distance "k" in the figure below must be 100-120mm for models 510A-520A and 130-150mm for models 530A-575A.

6.3.4. Level Difference

The level difference (measurement "n" in figure below) must be at least equal to the inner drain pipe diameter, i.e. 2" for disposer models 510A-520A and 2½" for models 530A-575A.

6.3.5. Slope of Drain Pipe

The slope of the drain pipe (measurement "f" in figure below) must not be less than 2:100. When the rate of flow of food waste is large, and/or where the distance from the disposer to the floor drain is great, a slope of (but not exceeding) 5:100 should be maintained. Installation of horizontal drain pipes must be avoided at all times.

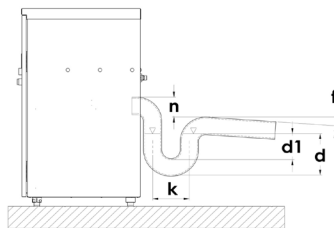

6.3.6. Vacuum Evacuation

For installations where the disposer is evacuated by means of a vacuum, a water trap must not be connected to the outlet of the disposer. Instead, the disposer is connected directly to the collection tank of the vacuum system. It is important that the drain pipe, between the disposer and the collection tank, has a ventilation pipe that is always open (as shown in the figure below). A ventilation pipe must be fitted even if the collecting tank has automatic airing.

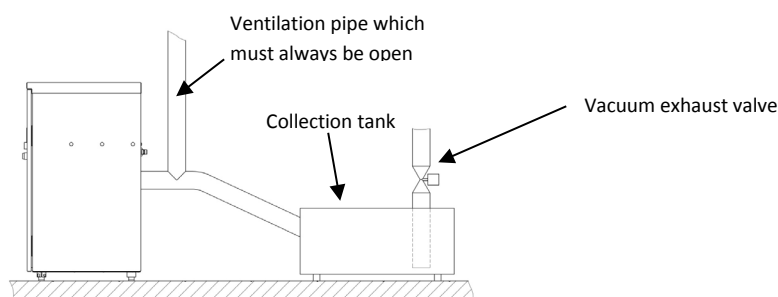

6.4. Electrical Connection

The electrical connection of the delivered disposer must be done by an authorized electrician and in accordance to local regulations. The wiring made from factory, and the electrical connection to be done at installation, is shown in the enclosed wiring diagram.



6.4.1. Supply Voltage

Check that the supply voltage corresponds to the specified voltage on the disposer's serial number plate, which is placed on the disposer housing.

6.4.2. Mains Fuses

Check that the supply voltage for the delivered disposer is fused as specified in section 3.2. of this manual.

6.4.3. Main Electrical Safety Switch

A separate main electrical safety switch must be connected. The electrical switch is not included in standard delivery but is available as an option from Disperator.

6.4.4. Cable Dimension

Use connection cable having 1.5mm² wires for disposers having a rated current up to 14A. For disposers having a current rated above 14A, use 2.5mm² wires. The rated voltage and current is specified on the disposer's serial number plate, which is placed on the disposer housing.

6.4.5. Cable Protection

All electrical cables must be protected against damage by being securely fastened, for example to the wall/bulkhead. If there is a risk that the cables can be damaged, for example by passing trolleys, then the cables must be protected by a flexible sleeve or conduit. The cables must never be kept on the floor/floor plate.



6.4.6. Earth Wire and Ground Fault Circuit Breaker

The earth wire must be longer than the main voltage wires, when connecting to the cable terminal block. This gives earth protection in case the voltage wires become unfixed in the cable nipple, allowing them to be pulled from their terminals. Installation of a separate ground fault circuit breaker (not included in the standard delivery from Disperator) has to be done.



6.4.7. Direction of Rotation for the Disposer

The disposer operates correctly irrespective of the motor's rotational direction. It is therefore irrelevant in which sequence the electrical phases are connected to the motor.

6.4.1. Safety Interlock Switch

Make sure that the safety interlock switch works properly. The disposer must stop if the protection lid is removed/opened. Adjust the safety interlock switch if necessary.

6.5. Start Up and Final Testing

Before starting the disposer, secure the laminated operation and safety instructions (enclosed) to the wall / bulkhead in a position where they are easily seen by the operator.

6.5.1. Grinder Check

Switch off the current at the main electrical safety switch and lock it with a padlock or a cable tie if you need to leave the disposer before you have completed section 6.5.

Check that the rotary shredder of the grinder in the inlet opening of the disposer turns freely in both directions by hand, and make sure that no foreign object has been dropped into the grinding unit during installation.



6.5.2. Checks before Start Up

Start the disposer and determine that the rotary shredder revolves and that flushing water flows automatically. Check assembly, flushing water connections and plumbing connections for possible leaks.

6.5.3. Final Mesures

If the disposer fails to operate, see section 9.3. "Trouble shooting" in this manual.

Instruct the personnel responsible for the disposer in the kitchen/galley about the operation of the disposer before handing over the remaining documentation and the jam release wrench.



7. Wiring diagram

A wiring diagram and bill of material, together with a component layout, is delivered with the disposer.

8. Safety Instructions

Read these Safety Instructions prior to using the disposer

1. Rotating disc under disposer inlet. Do not insert hands.
2. Disperator recommends usage of safety goggles when grinding bones and other types of hard food waste.
3. Immediately press the red stop-button if e.g. cutlery is found in the waste, or if unfamiliar noises coming from the disposer is heard. See section 9.3. "Trouble shooting".
4. If the disposer is running even though the safety protective lid above the disposer inlet is removed: Press the red stop-button, switch off the main electrical safety switch and call for service.
5. The main electrical safety switch must be locked in the Off-position, with a padlock or cable tie, during all maintenance and service work.
6. Depending on how the disposer is mounted and assembled to the surrounding kitchen furniture, it may emit a noise level of more than 70 dB(A). Disperator recommends that hearing protection is used when grinding bones and other types of hard food waste.



9. Operating Instructions

The disposer is intended for disposal of food waste only

- Food waste that is difficult to grind such as vegetables with long fibers, fish skins and sinewy meat should be divided into pieces of 3-5cm (1-2 inch) and mixed with other food waste before being ground.
- Dry and sticky waste such as steamed rice, pasta, mashed potatoes and bread should soak in water before being ground.
- Disposers having a motor power of 2.2kW or more, have the capacity to grind larger meat bones as well.



9.1. Start and Stop

1. Press the green button (1) - the disposer and flushing water starts.
2. Feed food waste into the disposer in an even and continuous manner.
3. When the grinding is completed the motor's idle sound is heard.
4. Wait 15 seconds. Press the red button (0) - the disposer and the flushing water will stop within 5 seconds.

9.2. Daily Cleaning

1. Press the green button (1) - the disposer and flushing water starts. Flush clean.
2. Press the red button (0) - the disposer and flushing water will stop within 5 seconds.
3. Use the main electrical safety switch to disconnect electrical supply. Lock the switch with a padlock or a cable tie if you need to leave the disposer temporarily before step 7 is completed.
4. Use protective gloves. Remove the protective lid above the disposer inlet.
5. Flush the discharge cone and the protective lid with water until clean.
6. Remount the protective lid. Make sure that the safety interlock switch connects.
7. Use the main electrical safety switch to connect the electrical supply.
8. Press the green button (1) to start and empty the disposer.
9. Press the red button (0) - the disposer and the flushing water will stop within 5 seconds.

9.3. Trouble Shooting

9.3.1. Disposer Reduces Speed, stops or does not start

A humming sound might be heard from motor

1. Press the red button (0).



2. Use the main electrical safety switch to disconnect electrical supply. Lock the switch with a padlock or a cable tie if you need to leave the disposer temporarily before step 10 is completed.
3. Use protective gloves. Remove the protective lid and check if something is jammed in the disposer.
4. If so, place the jam release wrench on the center washer. See picture below.

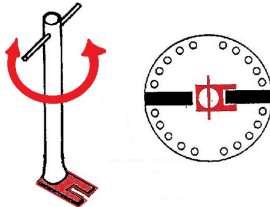

5. Release the grinder by rotating the wrench backwards and forwards until the shredder rotates freely in both directions. If needed, extend the bar on the wrench and hit the bar with a hammer.
6. Remove the jam release wrench.
7. Remove any non grindable objects; for example cutlery.
8. Remount the protective lid. Make sure that the safety interlock switch connects.
9. Check fuses/breakers. Change/reset if needed.
10. Use the main electrical safety switch to connect the electrical supply.
11. Press the green button (1) to start and empty the disposer.



9.3.2. The Disposer starts but there is no Flushing Water

1. Is the stop valve in the water supply pipe open? If not, open stop valve.
2. Is a clicking sound heard when activating the solenoid valve? If not, change the coil.
3. Is the line strainer clogged? Turn off water supply, open strainer and clean. Close strainer carefully without damaging the seal, and make sure it is tight when disposer is restarted.



9.3.3. The Disposer does not start and makes no Sound

1. Is the protection lid closed properly?
2. Check the main electrical safety switch; make sure that it is in an ON-position.
3. Check fuses/breakers. Change/reset if needed.

If the fault cannot be remedied please contact authorized service personnel or Disperator AB / local representative. Always provide the disposer's serial number when contacting Disperator.

10. Service Instructions

10.1. Authority

Dismantling and assembly of the disposer to flushing water, drain pipe and electrical services must be done by authorized personnel and in accordance to local regulations.



10.2. Exploded view of the Disposer

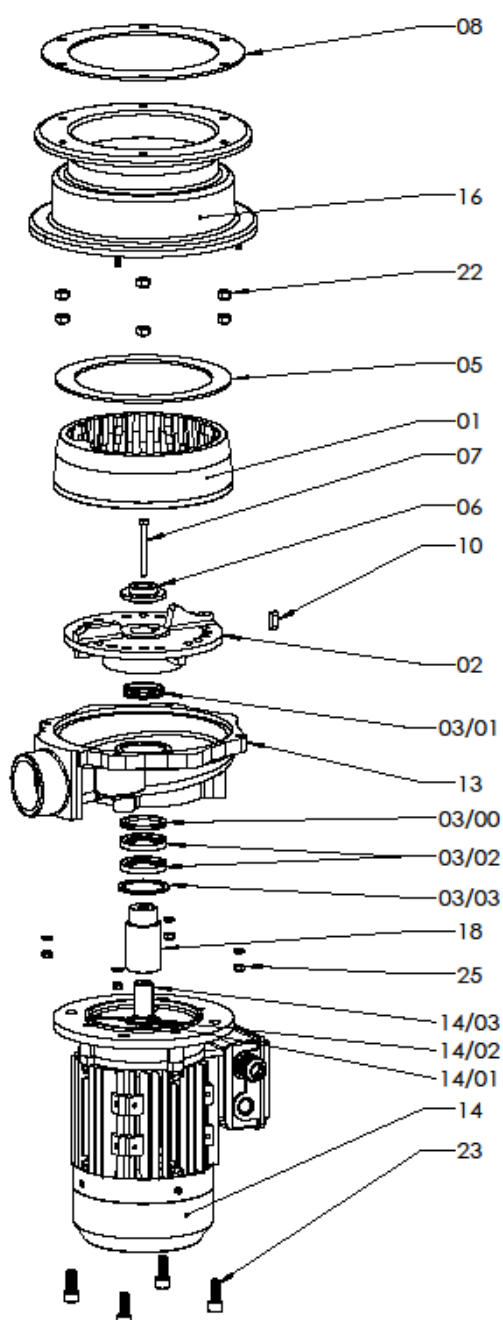

- 01 Stationary shredder
- 02 Rotary shredder
- 03/00 Washer for V-ring seal
- 03/01 V-ring seal
- 03/02 Axle seal, with stainless spring, 2 pcs
- 03/03 Locking ring, SgH
- 05 Seal for stationary shredder
- 06 Axle washer
- 07 Axle screw
- 08 Seal for hood flange
- 10 Key for carrier
- 13 End shield
- 14 Motor with drainage holes
- 14/01 Axle seal, 1 pcs. motor drive side,
1 pcs. motor fan side
- 14/02 Bearing, 1 pcs. motor drive side,
1 pcs. motor fan side
- 14/03 Key for motor shaft
- 16 Hood
- 18 Carrier
- 22 Nut for mounting the disposer, 6 pcs
- 23 Endshield mounting screw, 4 pcs.
- 25 Nut and washer for hood assembly, 4 pcs

Spare parts not shown in drawing

- 04 Special grease for seals and carrier
- 09 Rubber sealing compound
- 29 Adjustable leg, 4 pcs.
- 29/01 Screw for leg clamp, 4 pcs
- 31 Jam release wrench for rotary shredder
- 35 Solenoid valve, 1/2" BSP, Female incl. coil, cable plug and
fixating washer
- 36 Coil for solenoid valve
- 37 Line strainer, 1/2" BSP, Female
- 38 Start/stop unit including contactor with motor
overload protector
- 39 Safety Interlock Switch

ALWAYS STATE THE SERIAL NUMBER OF THE DISPOSER WHEN ORDERING SPARE PARTS.

NOTE! All nuts and screws must have the correct quality and strength.

Disperator can not guarantee the safety if other screws than those ordered from us are used.

10.3. Maintenance and Service of Assembly and Cabinet

For articles mentioned below, see exploded view of the disposer in section 10.2.

The following checks must be done in accordance to section 10.6. "Service and Maintenance Intervalls":

- make sure all nuts (-22) are properly tightend.
- make sure that the cabinet is securely fixated either to the wall/bulkhead or the floor.

10.4. Dismantling of Disposer

For below designation within brackets, see enclosed wiring diagram and exploded view of the disposer in section 10.2.

1. Use the main electrical safety switch to disconnect electrical supply and lock it with a padlock or a cable tie.
2. Disconnect the disposer cable from the contactor.
3. Disconnect the drain pipe from the end shield (-13) pipe connection.
4. Put a trolley under the motor. Disconnect the disposer (6 nuts -22).

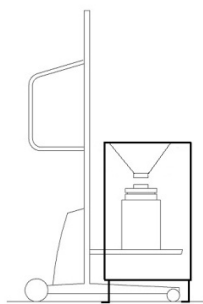

5. Remove the hood (-16) by loosening 4 nuts (-25). These 4 nuts (-25) must be changed before reassembly, as they are lock nuts. Make a mark on the hood and the end shield so that the discharge pipe will have the same direction after reassembly.

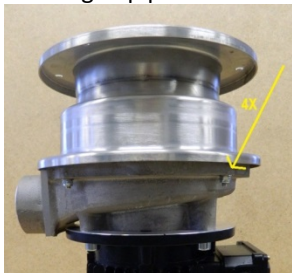

6. Pry the stationary shredder (-01) loose from the end shield (-13) using a crowbar that levers against the large tooth on the inside rim, and is supported by the rotary shredder (-02) close to one of the two shredder blades. See foto below



7. Loosen the axle screw (-07). If the rotating shredder (-02) keeps turning, and can not be held still manually, use a pipe wrench to hold one of its shredder blades.
8. Remove the rotary shredder (-02) by placing two crowbars opposite one another under the rim of the shredder, supported by the side of the end shield (-13).

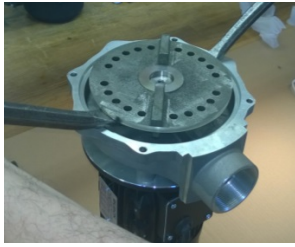

9. Remove the V-ring seal (-03/01) and loosen the 4 fixing screws (-23) of the end shield (-13). Remove the end shield (-13). Inspect the washer (-03/00) for possible wear caused by the V-ring seal and replace the washer if necessary.

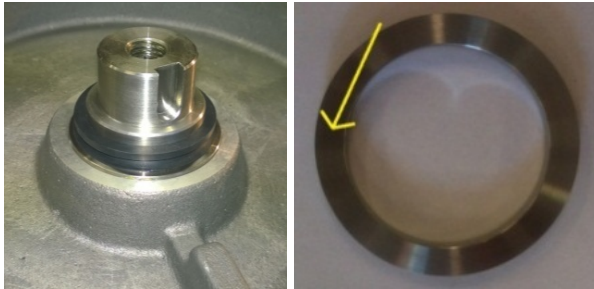

10. Turn the end shield (-13) upside down and remove the locking ring (-03/03) by means of a circlip pliers. With some adequate protection in between, apply pressure to the washer (-03/00) in order to get the two axle seals (-03/02) out. Make sure that the surface of the washer is in good condition. Examine the contact surface of the carrier (-18) for wear caused by the axle seals. There should only be two small symmetrical tracks on the carrier if it has been running correctly. Replace the carrier if necessary.
11. Terminate dismantling here when only replacing the stationary and rotary shredders. Start the reassembling from section 10.5.5.
The V-ring seal (-03/01) and the two axle seals (-03/02) with special grease (-04) together with stationary seals (-05) and (-08) must be replaced with every overhaul.
12. Remove the carrier (-18) carefully. If it is stuck, use the supplied carrier removal screw, on the top of the carrier and screw it down. This will remove the carrier from the motor axle. If needed, use the rotary shredder (-02) as a handle to prevent the motor axle from rotating.
13. When changing the motor (-14), make sure that the new motor has the same classification and quality as the original. The motor must have holes to allow for ventilation and drainage of water condensation (see picture below and original motor). If drilling holes in the motor, it is important to drill at the right angle, so that there is no damage to the motor or any of its parts. All replacement motors delivered by Disperator have premade drainage holes.

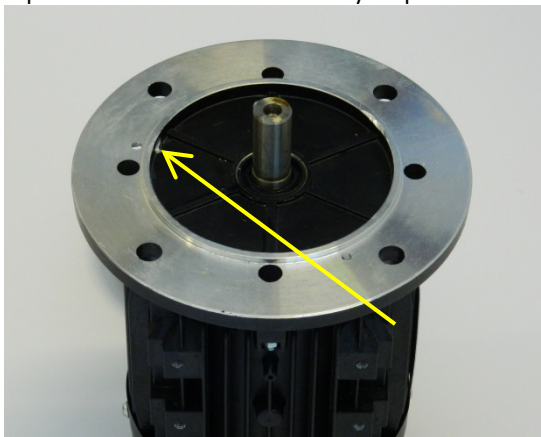

10.5. Assembly of Disposer

1. Clean all components carefully. Wipe the surface of the motor (-14) and the shaft. Make sure that there is no dust or grease residue.
2. Make sure that the key (-14/03) is in the correct position. Apply a thin layer of Disperator special grease (-04) on the motor shaft.
3. Wipe the carrier (-18) clean of residue on the inside and outside.
4. Mark the depth of the hole in the carrier (-18) onto the motor axle. The depth is 38mm for models 510A - 515A, 48mm for model 520A and 58mm for models 530A - 575A. Carefully press the carrier (-18) onto the motor axle all the way down to the mark. If hand power is not sufficient, use the axle screw (-07) as a mounting tool. Use the rotary shredder (-03) as a handle if needed.
5. Wipe the inside of the hole on the end shield (-13) clean of residue.
6. Place the washer (-03/00) in the end shield (13) with the flange facing towards the motor.
7. Grease the sealing face of end-shield (-13) with special grease (-04).
8. To avoid damaging the seals (-03/02, 2pcs) press each seal one at the time into position using a tool that has the same outer diameter as these seals. The seals shall be placed with the groove and stainless spring upwards towards the washer (-03/00).
9. The seals are fixated by fitting the locking ring (-03/03) into the groove in the end shield (-13). Tap on this ring to ensure that it is seated properly in the groove in the end shield.
10. Grease the axle seals (-03/02) and pack the space between the two seals with special grease (-04). Use a soft brush.



11. Apply a thin layer of special grease (-04) on the carrier (-18). Use a soft brush.
12. Fit the end shield (-13) with the outlet facing away from the connection box on the motor. Care should be taken not to damage the lips of the axle seals. Tighten all four screws (-23). The torque should be 50Nm for models 510A-520A and 81Nm for models 530A-575A.
13. Grease the V-ring seal (-03/01) and washer (-03/00) using special grease (-04). Fit the V-ring seal over the carrier (-18) with the seal lip against the washer (-03/00).
14. Fix the carrier key (-10) with grease.



15. Wipe the axle hole in the rotary shredder (-02) clean. Also make sure that the mating surfaces on the end shield (-13) and the stationary shredder (-01) are clean.
16. Fit the rotary shredder (-02) on the carrier (-18).
17. Wipe the carrier (-18) clean from excess grease.
18. Apply a layer of rubber sealing compound (-09) over the joint between shredder and carrier axle. Make sure that the thread is free from sealing compound.
19. Fit the washer (-06) and tighten the axle screw (-07). The torque should be 9.3Nm for models 510A-515A, 22Nm for model 520A and 44Nm for models 530A-575A.

20. Apply a thin continuous string of rubber sealing compound (-09) in the seat of the end shield (-13).



21. Carefully position the stationary shredder (-01) with the large tooth at the outlet of the end shield (-13).
 22. Tap the stationary shredder (-01) with a plastic hammer to fix it in the end shield (-13) and make sure that the stationary shredder is in the correct place.
 23. Secure the stationary shredder to the end shield by hammering 6 punch marks around the joint between these two articles.



24. Put the rubber seal (-05) on the stationary shredder (-01). Make sure that it is centered.



25. Wipe the surface of the hood (-16) that faces the rubber seal clean.
 26. Carefully fit the hood (-16) so that its outside arrow mark is positioned centrally to the waste outlet on the end shield (-13).
 27. Secure the hood with 2 nuts (-25) and 2 washers (-25/1) on the two non highlighted positions (see section 10.4. step 6). The torque should be 9,5Nm for models 510A-520A and 21Nm for models 530A-575A.
 28. Secure the hood with 4 nuts (-25) and 4 washers (-25/1). The torque should be 9,5Nm for models 510A-520A and 21Nm for models 530A-575A.

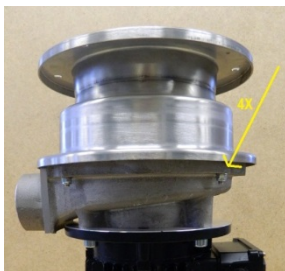

29. The disposer is now ready to be refitted, use a trolley as support.

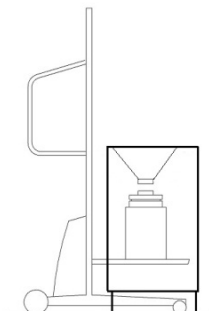

30. Make sure that the seal for the hood (-08) is placed correctly before you move the disposer into place. Use 6 pcs of nuts (-22).
31. Reconnect water supply according to 6.2 and drain piping according to section 6.3. Make sure that the disposer is securely fixed so it can withstand the start torque. Connect the electricity according to section 6.4.
32. Start up the disposer according to the startup procedure described in section 6.5.

10.6. Service and Maintenance Intervals

Maintenance	Interval	Comments
Cleaning of disposer	Daily	See section 9.2. in this user manual
Check line strainer	First time after a month then when needed	See section 9.3.2. in this user manual
Check cabinet	First time after a month then when needed	See section 10.3. in this user manual
Preventive maintenance	After approx. 3000 hours of use or latest after 5 years	Service pack 1
Replacement of parts due to wear	After approx. 9000 hours of use	Service pack 2
All other parts	When needed	

10.7. Spare Parts

10.7.1. Service Packs

Always state the serial number of the disposer when ordering spare parts

Below mentioned reference numbers refer to the exploded view in section 10.2. All parts of Service Pack 1 are also included in Service Pack 2.

Service pack 1

Reference number	Name	Qty.
-03/00	Washer for V-ring seal	1 pc.
-03/01	V-ring seal	1 pc.
-03/02	Axle seal, with stainless spring	2 pcs.
-03/03	Locking ring	1 pc.
-04	Special grease for seals and carrier	1 pc.
-05	Seal for stationary shredder	1 pc.
-07	Axle screw	1 pc.
-08	Seal for hood flange	1 pc.
-09	Rubber sealing compound	1 pc.
-10	Key for carrier	1 pc.
-22	Screw and nut for mounting the disposer	6 pcs.
-23	Screw for end shield	4 pcs.
-25	Nut and washer for hood, stainless	4 pcs.
-26	Screw and washer for housing , stainless	2 pcs.

Service Pack 2

Reference number	Name	Qty.
-01	Stationary shredder	1 pc.
-02	Rotary shredder	1 pc.
-03/00	Washer for V-ring seal	1 pc.
-03/01	V-ring seal	1 pc.
-03/02	Axle seal, with stainless spring	2 pcs.
-03/03	Locking ring	1 pc.
-04	Special grease for seals and carrier	1 pc.
-05	Seal for stationary shredder	1 pc.
-06	Axle washer	1 pc.
-07	Axle screw	1 pc.
-08	Seal for hood flange	1 pc.
-09	Rubber sealing compound	1 pc.
-10	Key for carrier	1 pc.
-18	Carrier	1 pc.
-22	Screw and nut for mounting the disposer	6 pcs.
-23	Screw for end shield	4 pcs.
-25	Nut and washer for hood, stainless	4 pcs.
-26	Screw and washer for housing , stainless	2 pcs.
	Carrier removal screw	1 pc.

10.7.2. Identification Guide for 500A EXCELLENT SERIES Spare Parts

Below mentioned reference numbers refer to the exploded view in section 10.2.

		
-01. Stationary shredder, 1pc	-02. Rotary shredder, 1pc	-03/00. Washer for V-ring seal, 1pc
		
-03/01. V-ring seal, 1pc	03/02. Axle seal with stainless spring, 2pcs	-03/03. Locking ring, 1pc
		
-04. Special grease for seals and carrier, 1pc	-05. Seal for stationary shredder, 1pc	-06. Washer, 1pc
		
-07. Axle screw, 1pc	-08. Seal for hood flange, 1pc	-09. Rubber sealing compound, 1pc

		
-10. Key for carrier, 1pc	-13. End shield, 1pc	-14 Motor with drainage holes, 1pc
		
-14/01 Axle seal motor	14/02. Motor bearing	-14/03 Key for motor shaft, 1pc
		
-16 Hood, 1pc	-18 Carrier, 1pc	-22 Nut for mounting the disposer, 6pcs
		
-23 Motor mounting screw, 4pcs	-25 Nut and washer for hood assembly, 4pcs	-29 Adjustable legs, 4 pcs

		
<p>-31 Jam release wrench, for rotary shredder, 1pc</p>	<p>35 Complete solenoid valve with coil, cable plug and fixing washer, 1pc</p> <p>-36 Coil for solenoid valve, 1pc</p>	<p>-37 Line strainer, 1pc</p>
		
<p>-38 Start/stop unit including contactor with motor overload protector, 1pc</p>	<p>-38/1 Contactor with coil, 1pc</p>	<p>-38/2 Auxiliary contact, 1pc</p>
		
<p>-38/3 Motor protector, 1 pc</p>	<p>-39 Safety interlock switch, 1pc</p>	