

metos

BRATT PAN

METOS PRINCE 60, 85

Accessories:

Water tap 3755416

Height adjustment 3755414

Free standing

Installation and operation manual



Rev. 1.3
(15.6.2026)

3755400, 3755401, 3755402, 3755403, 3755400N, 3755401N, 3755402N, 3755403N, 3755401MO, 3754415M,
3754416M, 3754417M, 3754418M, 3754425M, 3754426M, 3754426MO, 3754427M, 3754428M, 3754428MO,
3755403MO 4210800, 4210802, 4210804, 4210806

TABLE OF CONTENTS

1.	General	3
1.1.	Symbols used in the manual.....	3
1.2.	Symbols used on the appliance.....	3
1.3.	Checking the relationship of the appliance and the manual.....	3
2.	Safety	4
2.1.	Safe use of the appliance.....	4
2.2.	Safety instructions in case of malfunction.....	4
2.3.	Disposal of the appliance.....	4
3.	Functional description	5
3.1.	Intended use of the appliance.....	5
3.1.1.	Use for other purposes.....	5
3.2.	Operating principle.....	5
4.	Operation instructions	5
4.1.	Before use.....	5
4.1.1.	Preparing the use.....	5
4.2.	Operation.....	6
4.2.1.	Switching on the bratt pan.....	6
4.2.2.	Setting of the frying temperature.....	7
4.2.3.	Frying temperature.....	7
4.2.4.	Tilting.....	8
4.2.5.	Filling the water.....	8
4.2.6.	Adjustment the working height.....	8
4.3.	After use.....	8
4.3.1.	Cleaning.....	8
4.3.2.	Service.....	9
5.	Installation	10
5.1.	Transporting and unpacking the bratt pan.....	10
5.2.	Positioning the bratt pan.....	10
5.3.	Electrical connections.....	10
5.4.	Water connection (W).....	10
5.5.	Test-run.....	11
6.	Troubleshooting	12
7.	Technical specifications	13

1. General

Carefully read the instructions in this manual as they contain important information regarding proper, efficient and safe installation, use and maintenance of the appliance.

Keep this manual in a safe place for eventual use by other operators of the appliance.

The installation of this appliance must be carried out in accordance with the manufacturer's instructions and following local regulations. The connection of the appliance to the electric and water supply must be carried out by qualified persons only.

Persons using this appliance should be specifically trained in its operation.

Switch off the appliance in case of failure or malfunction. Have the appliance serviced by a technically qualified person authorized by the manufacturer and using original spare parts.

Not complying with the above may put the safety of the appliance in danger.

1.1. Symbols used in the manual



This symbol informs about a situation where a safety risk might be at hand. Given instructions are mandatory in order to prevent injury.



This symbol informs about the right way to perform in order to prevent bad results, appliance damage or hazardous situations.



This symbol informs about recommendations and hints that help to get the best performance out of the appliance.

1.2. Symbols used on the appliance



This symbol on a part informs about electrical terminals behind the part. The removal of the part must be carried out by qualified persons only.

1.3. Checking the relationship of the appliance and the manual

The rating plate of the appliance indicates the serial number of the appliance. If the manuals are missing, it is possible to order new ones from the manufacturer or the local representative. When ordering new manuals it is essential to quote the serial number shown on the rating plate.

2. Safety

2.1. Safe use of the appliance



Because the bratt pan is a heated appliance that has hot surfaces during normal use, the following warnings and instructions must be followed to avoid burns:

- During long-time operation even the sides of the frying surfaces, the pouring nose and the lid get hot.
- For safe frying, always use heat protective gloves and appropriate accessories.
- Look out for discharging steam when opening the lid, especially when simmering or stewing.
- Do not leave the bratt pan on for long periods totally without supervision.



It is strictly forbidden to use bratt pan as a deep fat fryer.

2.2. Safety instructions in case of malfunction



Switch off the appliance if it is damaged or malfunctioning. Contact authorised service personnel using original spare parts for service of the appliance.

2.3. Disposal of the appliance

The destroying of the appliance when the end of its economical lifetime has been reached must be carried out in accordance with local rules and regulations. Taking care of substances that might be harmful to the environment, if not properly handled, and utilization of reusable materials is best done by using professional personnel specializing in recycling.

3. Functional description

3.1. Intended use of the appliance

Prince bratt pan is intended for heating, frying and stewing of food.

3.1.1. Use for other purposes

Use of the appliance for other purposes than stated above is prohibited.

The manufacturer of the appliance takes no responsibility for situations that may occur if warnings and instructions in this manual are neglected.

3.2. Operating principle

The frying surface of the bratt pan is heated by specially designed heating elements that are controlled by a thermostat. The yellow pilot light goes off when the preset frying temperature is reached.

The tilting of the bratt pan is electrical and is controlled by push buttons on the control panel.

- The bratt pan models with letter W in the type marking are equipped with the possibility to fill bowl of the bratt pan by cold water.
- The bratt pan models with letter H in the type marking are equipped with the possibility to adjust the working height of the bratt pan.

4. Operation instructions

4.1. Before use

4.1.1. Preparing the use



Using the appliance for the first time or when heating elements have been changed, turn on the bratt pan at MINIMUM temperature for SEVERAL hours or until the insulation resistance is OK. This allows remaining humidity in the heating elements to dry up. In fact, on first connection, the earth insulation can be relatively inadequate, but after the above-mentioned initialization run the insulation level will normally be re-established according to CEI 18-6 part 307 regulations.



Setting the power or temperature to maximum right away at first run may damage the heating elements or the cooking plates.

In unclear cases contact our technical support:
technical.support@metos.com



After the cleaning, the frying surface must be burned in with salt-free grease. Heat up the pan to 200°C keeping the lid closed. Burn the grease for 5-10 minutes, let the pan cool down and wipe off excessive grease. Repeat when necessary. Do not use oil for burning. Heated oil would create a tough surface, which is difficult to clean. A well greased pan reduces fat consumption in frying and minimizes burning of foodstuffs.

4.2. Operation

4.2.1. Switching on the bratt pan

During the installation, a mains switch may have been fitted near the bratt pan, often on a wall nearby. Check that the mains switch is in the ON position.

The bratt pan is controlled from the operating panel.

The pan is switched on by turning the thermostat knob to the desired frying temperature, whereafter

- the heating-up starts
- the green pilot light goes on
- the yellow pilot light goes on, and it goes off when the preset temperature is reached.

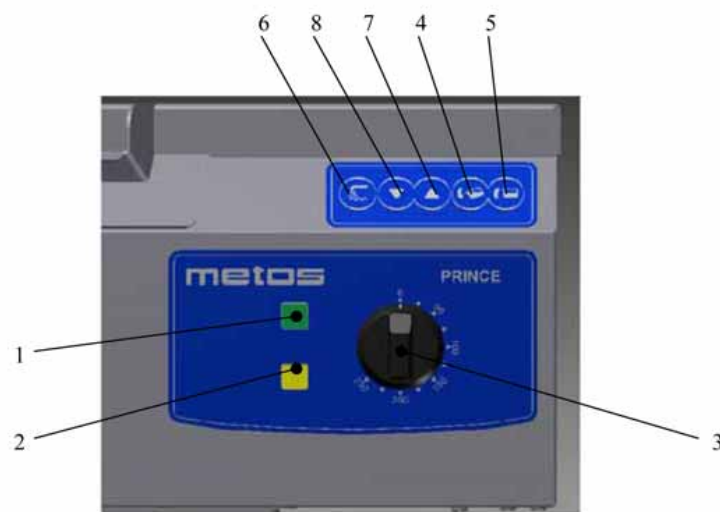

Operating panel

- | | |
|---|--|
| <ol style="list-style-type: none"> 1. Green pilot light PAN SWITCHED ON 2. Yellow pilot light TEMPERATURE 3. Temperature adjustment 4. Pan bowl tilting 5. Return pan bowl to working (horizontal) position 6. Water filling (optional) | <ol style="list-style-type: none"> 7. Increment of bratt pan height (optional) 8. Decrement of bratt pan height (optional) |
|---|--|

Heating up to the frying temperature takes about 5-6 minutes. When the preset frying temperature is reached, the yellow pilot light goes off.



If there are longer interruptions in the electricity distribution, the thermostat should be set to the 0 position. This should be done in order to prevent unexpected start-up of the pan when the electricity distribution is restored.



Due to the very short preheating time of the bratt pan, energy can be saved by not switching the pan on until the frying is started. If there is a longer pause during the frying, the bratt pan can be switched off or the temperature can be set to a lower value. Energy can also be saved by keeping the lid closed always when possible, for instance when simmering or stewing.

4.2.2. Setting of the frying temperature

The frying temperature can be changed by turning the thermostat knob to the desired temperature. When lowering the temperature, some time will be needed for the frying surface to cool down. Increasing of the temperature turns on the yellow pilot light. The new temperature is reached when the light goes off.

4.2.3. Frying temperature

Guiding temperatures for various products:

Fried eggs	150°C
Omelette	160°C
Fish	170°C
Bacon	150°C
Meat cubes	170°C
Meat balls, depending on size	130°C...170°C
Hamburgers, depending on size	130°C...170°C
Veal fillet	170°C
Wiennasteak	170°C
Thin steak of veal	220°C
Broiler, big pieces	150°C
Floured slices of liver	170°C
Chops	170°C
Sausage cubes	130°C...150°C
Frankfurters	150°C
Fried potatoes	150°C...170°C
Mushrooms	130°C...150°C
Onion	140°C
Small pancakes	170°C

4.2.4. Tilting



Before tilting or returning the bratt pan bowl to the working position, check that nothing is in the movement area or leaning against the moving part of the bratt pan.

The tilting of the pan bowl is operated with a push button (4) (See figure "Operating panel" in section 4.2.1 on page 6). To tilt pan bowl at desired angle push and hold "tilting" button (4). To return pan bowl to working (horizontal) position push and hold "return" button (5) until pan bowl stop. The pan cannot be tilted while the lid is closed.

When tilting the pan bowl, the heating is switched off and will be switched on again when the pan is in the horizontal position.

4.2.5. Filling the water

Filling the cold water is possible in bratt pan models with additional letter W included in model marking. These models have additional push button (6) on the operating panel for the option (See figure "Operating panel" in section 4.2.1 on page 6). To fill the water push and hold button until required amount of water collected.

Filling the water is possible when lid of the bratt pan opened.

4.2.6. Adjustment the working height

The free-standing model does not have this option.



Before adjusting the working height of the bratt pan, check that nothing is in the movement area or leaning against the moving part of the bratt pan.

Adjustment of working height is possible in bratt pan models with additional letter H included in model marking. These models have two additional push buttons (7 and 8) on the operating panel for the option (See figure "Operating panel" in section 4.2.1 on page 6).

Adjustment is not possible if pan bowl is in tilted position.

4.3. After use

4.3.1. Cleaning

Burned deposits on the frying surface of the pan form an isolating layer which slows up the frying and creates poor frying results. A clean frying surface is a must for good-quality results.



180°C



approx. 135°C

The effect of burned deposits on the surface temperature: 2 mm of deposits lower the surface temperature with 24 % (180°C -> about 135°C).



Always disconnect the power supply to the bratt pan before cleaning it.

Cleaning equipment: scraper, hard brush, scouring plate, towel, kitchen paper.

Cleaning detergent: slightly alkaline detergent (pH 8-10).

Cleaning method: scraping, dry, wet, damp.

Precleaning:

Scrape out frying remains and wipe out grease and loose remains with paper. When necessary, pour hot water into the pan and let soak.

Cleaning:

Clean the inside of the pan with a brush and hot water. Remove the spots with a scouring plate. Cleaning detergent should be used only for frying surfaces extremely covered with burned deposits, because it removes grease from the frying surface.

Clean the inner and outer surfaces of the lid with a brush and cleaning detergent solution.

Clean the base and outer surfaces of the pan with a brush and cleaning detergent solution and rinse with water.

Rinse the frying surface of the pan with hot water, dry by heating up and grease with salt-free grease. Rinse all other surfaces and wipe dry.



Water usage on the control panel and the electric box must be avoided.



Use of a water hose or pressure cleaning jet is strictly forbidden.



In order to remain in good condition, the frying surface must be burned with salt-free grease when the pan is taken into use for the first time, and after that at intervals during use. This is especially necessary in connection with thorough cleaning.

4.3.2. Service

Switch the appliance off if it is damaged or is malfunctioning. Contact authorized service personnel using original spare parts for service of the appliance.



The appliance does not include any user serviceable parts inside. Service must be left to authorized service personnel.

5. Installation

5.1. Transporting and unpacking the bratt pan

The best way to move the bratt pan is to keep it in its own package as long as possible while it also protects the pan from outer damage. If it is necessary to unpack the pan, possible lifting must thereafter be done from the bottom frame of the base by using suitable spacers of wood. In order to avoid damage, it is not allowed to use the lid as a workbench during installation.

5.2. Positioning the bratt pan

Model fixed to the floor:

The installation is started by mounting the installation frame by bolts to the floor considering a possible floor drain. The recommended distances needed for service are shown in the installation drawing. After this lift pan onto installation frame.

Thereafter the pan is adjusted into a horizontal position by turning the adjustable bolts. The correct position is checked from the frying surface, not from the outer edges of the pan.



When the bratt pan is on the correct location and in a horizontal position, support pillar must be bolted to the installation frame.



The bratt pan (without optional water tap) can be installed tight to rear wall. Two holes on the rear surface of support profile can be used for additional fixing of bratt pan to the rear wall. Refer to the installation drawing for details.

Free standing model (FS):

Adjust the bratt pan to a horizontal position by adjusting the height of the feet. The correct position is checked from the frying surface, not from the outer edges of the pan. See also the installation drawing in section 7.

5.3. Electrical connections



In order to make eventual future service easier and to increase safety, a mains switch must be installed near the appliance. This switch must disconnect the appliance completely from the electrical supply network.

Connection terminals are inside of support pillar. Entry for connection cable is made through the bottom of the support pillar or through the grommet on the rear wall of the support pillar. In order to make the connection, the front panel of the support pillar must be removed. To remove front panel loose two screws and than move panel downward and then towards yourself.



For bratt pan with optional height adjustment entry for connection cable is made only through the bottom of the support pillar. In order to make the connection, the front panel of the support pillar must be removed. To remove front panel loose four screws and than move panel towards yourself. Connection terminals are behind internal front cover. Loose two screws and remove internal front cover to get access to the connection terminals.

5.4. Water connection (W)



Connection to cold water supply must be made by pressure resistant hose (not included in delivery) fitted with G 3/4 connector. The water connection must be fitted with shut-off valve and non-return valve (not included in delivery).

Rinse the water hose before making the water connection.



The length of water hose must be sufficient to compensate movement of connection point in up- and downward direction for bratt pan with optional adjustment.

5.5. Test-run



Besides the live electrical parts also look out for possible moving parts of the appliance (pan bowl and lid).

After connecting the cable check the function of the bratt pan.

Check that when turning the thermostat knob, both the green and yellow pilot light goes on



The bratt is equipped with safety thermostat. Safety thermostat prevents bratt pan from overheating if main thermostat does not switch off heating elements.

After installation of the bratt pan during test-run **check** the condition of safety thermostat. If after turning the thermostat knob at desired temperature **only** green pilot lamp goes on but yellow pilot lamp remains off then safety thermostat need to be reset. Contact an authorized service person to reset safety thermostat.

Check that the yellow pilot light goes off after a few minutes when the frying surface has reached the set temperature.

Check that the limit switches of the heating work properly: when tilting the heating is switched off, the return movement stops when the pan reaches the base and the heating is switched on. If necessary, adjust the limit switches.

Before refitting the front panel, **check** that no wires in the base interfere with moving parts.

Refit the lower front panel.

6. Troubleshooting

If the appliance does not function, check the following:

- Has the appliance been used according to the instructions?
- Are all possibly removable parts refitted?
- Are the mains switch on the appliance or nearby - often on the wall - in the ON position?

If even this does not help, figure out in advance how to briefly describe the break-down and contact an authorized service person.



The appliance does not include any user serviceable parts inside. Service must be left to authorized service personnel.

7. Technical specifications

Voltage codes

Product codes

Main and control circuit diagram T02711D3

Connection diagram T03463B3

Heating element connection T02712B3

Installation drawing, basic model T03278C3

Installation drawing, model W (Water connection) T03476B3

Installation drawing, model H/HW (Working height/Working height, Water connection) T03477B3

Installation drawing, model FS (Free-standing)

Technical specification table

Voltage codes

Voltage code	Voltage
A	3/N/PE~400/230V 50Hz
B	~250V 16A 50Hz
C	3/N/PE~380/220V 50Hz
D	3/PE~200V 50-60Hz
F	2/PE 220-240V 50Hz
G	3/N/PE~415/240V 50Hz
H	3/PE~230V 50Hz
I	3/PE~220V 60Hz
J	3/PE~380 50Hz
K	3/PE~400V 50Hz
L	3/PE~415V 50Hz
M	3/PE~440V 60Hz
N	3/PE~460V 60Hz
O	3/PE~480V 60Hz
P	1/N/PE~220-240V 50Hz
R	2/PE~220-230V 60Hz

Product codes

Type codes	Full name	Description
60		
85		
Model codes		
DC	Prince DC	Pan depth 130 or 180mm with bottom made from construction steel
LC	Prince LC	Pan depth 90mm with bottom made from construction steel
Accessory codes		
W		Water tap
H		Height adjustment

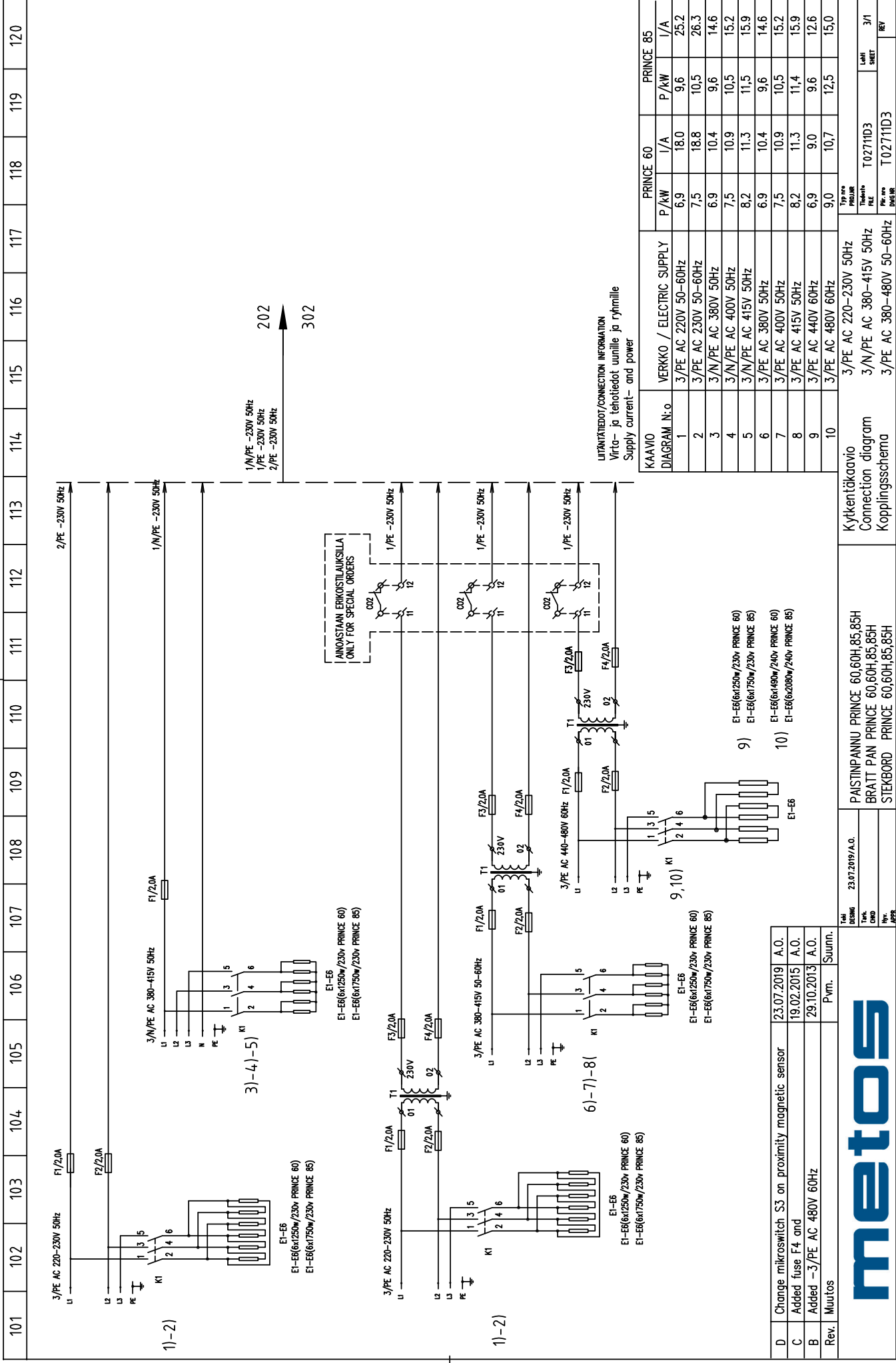

D	Change mikroswitch S3 on proximity magnetic sensor	23.07.2019	A.O.
C	Added fuse F4 and	19.02.2015	A.O.
B	Added -3/PE AC 480V 60Hz	29.10.2013	A.O.
Rev.	Muutos	Pvm.	Suunn.

TAI DC/DC	23.07.2019/A.O.
TEK. CHD	
RYV. LPPR	

Kytkentäkaavio
Connection diagram
Kopplingschema

PAISTINPANNU PRINCE 60,60H,85,85H
BRATT PAN PRINCE 60,60H,85,85H
STEBKORD PRINCE 60,60H,85,85H



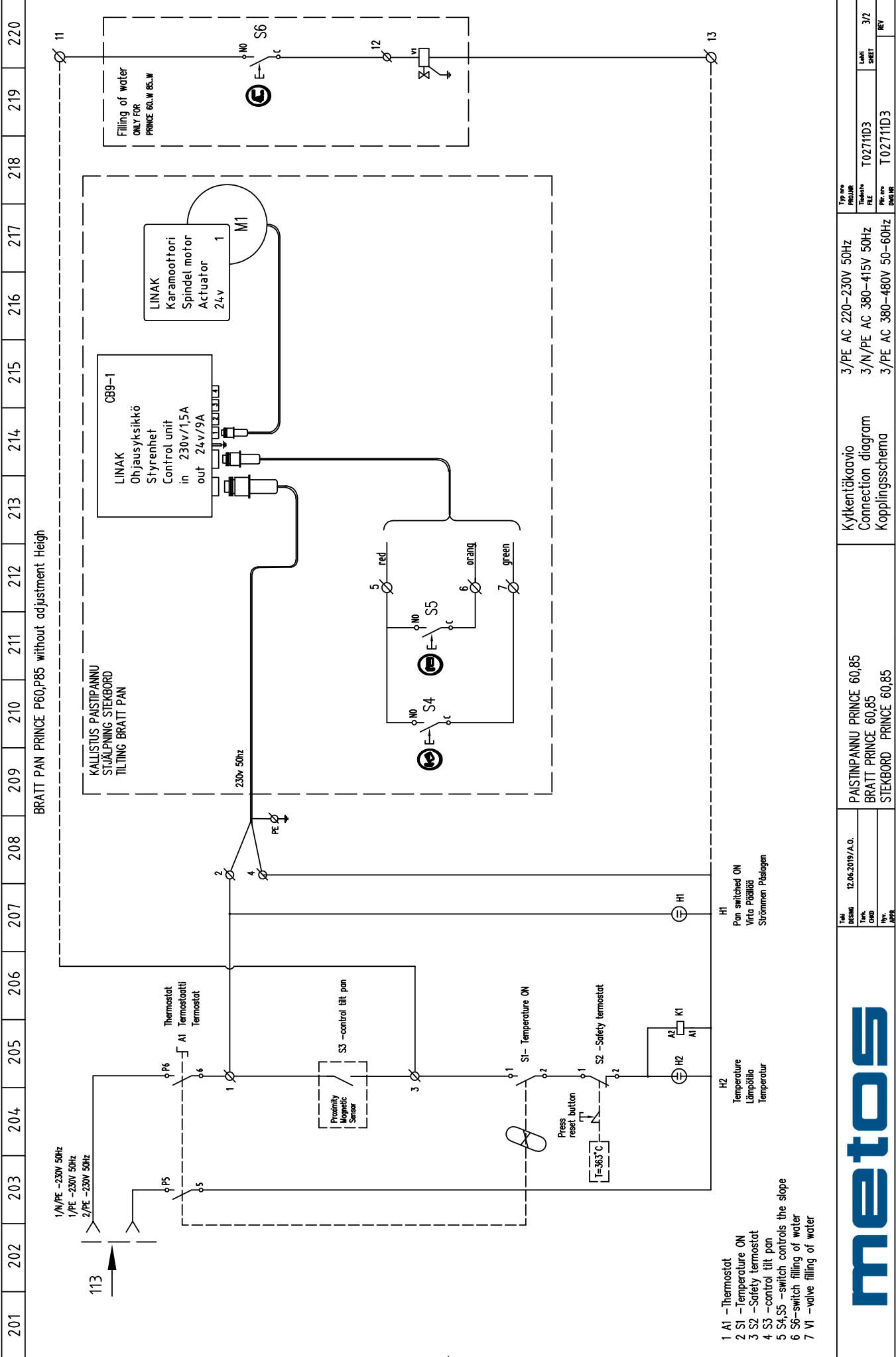

BRATT PAN PRINCE P60.P85 without adjustment Height

- 1 A1 -Thermostat
- 2 S1 -Temperature ON
- 3 S2 -Safety thermostat
- 4 S3 -control tilt pan
- 5 S4,S5 -switch controls the slope
- 6 S6-switch filling of water
- 7 V1 -valve filling of water

PAISTIPANNU PRINCE 60,85 BRAIT PRINCE 60,85 STEBBORD PRINCE 60,85		Kytentäkaavio Connection diagram Kopplingschema		3/PE AC 220-230V 50Hz 3/N/PE AC 380-415V 50Hz 3/PE AC 380-480V 50-60Hz		Typ no PRINCE T02711D3 T02711D3		Lehti SHEET 3/2	
Tel 02000 12.06.2019/A.O.		PAISTIPANNU PRINCE 60,85 BRAIT PRINCE 60,85 STEBBORD PRINCE 60,85		3/PE AC 220-230V 50Hz 3/N/PE AC 380-415V 50Hz 3/PE AC 380-480V 50-60Hz		Typ no PRINCE T02711D3 T02711D3		Lehti SHEET 3/2	
Vir. Omb Mv.		Virto Pöytäliig Strömmen Pislagen		Virto Pöytäliig Strömmen Pislagen		Virto Pöytäliig Strömmen Pislagen		Virto Pöytäliig Strömmen Pislagen	



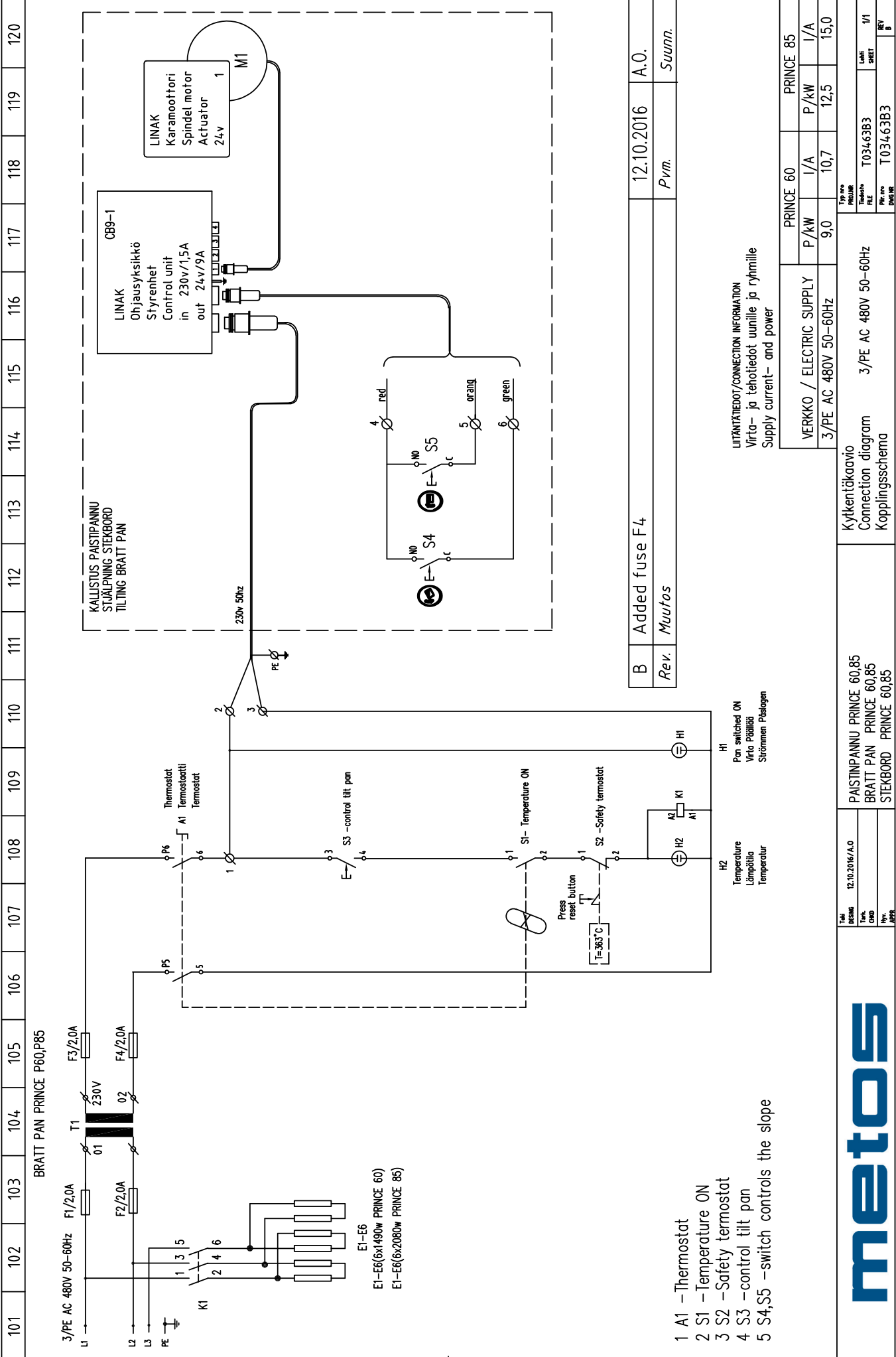

BRATT PAN PRINCE P60,P85

3/PE AC 480V 50-60Hz F1/2,0A F2/2,0A F3/2,0A F4/2,0A

T1 230V 01 02

PE 1 2 3 4 5 6

K1

E1-E6

E1-E6(6x1490W PRINCE 60)
E1-E6(6x2080W PRINCE 85)

Thermostat A1 Temmostatitii Termostat

S3 -control tilt pan

S1 -Temperature ON

S2 -Safety thermostat

Press reset button

T=385°C

H2 Temperature Lämpötila Temperatur

H1 Pan switched ON Virta Päälitää Strömmen Påslagen

PAISTIPANNU PRINCE 60,85
BRATT PAN PRINCE 60,85
STEBORD PRINCE 60,85

12.10.2016/A.O.

12.10.2016 A.O.

PRINCE 60 PRINCE 85
P/kW I/A P/kW I/A
9,0 10,7 12,5 15,0

VERKKO / ELECTRIC SUPPLY
3/PE AC 480V 50-60Hz

3/PE AC 480V 50-60Hz

Kytkentäkaavio
Connection diagram
Kopplingschema

Typ no PRINCE
Tilanne- T03463B3
PCE
PCE no T03463B3
PRINCE

Lehti I/1
SHEET

Rev. Muutos
Suunn.

LITÄNTÄTIEDOT/CONNECTION INFORMATION
Virta- ja teh tiedot uunille ja ryhmille
Supply current- and power

Added fuse F4
A.O.

12.10.2016 A.O.

PRINCE 60 PRINCE 85

P/kW I/A P/kW I/A

9,0 10,7 12,5 15,0

VERKKO / ELECTRIC SUPPLY

3/PE AC 480V 50-60Hz

3/PE AC 480V 50-60Hz

Kytkentäkaavio

Connection diagram

Kopplingschema

Typ no PRINCE

Tilanne- T03463B3

PCE

PCE no T03463B3

PRINCE

Lehti I/1

SHEET

Rev. Muutos

Suunn.

LITÄNTÄTIEDOT/CONNECTION INFORMATION

Virta- ja teh tiedot uunille ja ryhmille

Supply current- and power

Added fuse F4

A.O.

12.10.2016 A.O.

PRINCE 60 PRINCE 85

P/kW I/A P/kW I/A

9,0 10,7 12,5 15,0

VERKKO / ELECTRIC SUPPLY

3/PE AC 480V 50-60Hz

3/PE AC 480V 50-60Hz

Kytkentäkaavio

Connection diagram

Kopplingschema

Typ no PRINCE

Tilanne- T03463B3

PCE

PCE no T03463B3

PRINCE

Lehti I/1

SHEET

Rev. Muutos

Suunn.

LITÄNTÄTIEDOT/CONNECTION INFORMATION

Virta- ja teh tiedot uunille ja ryhmille

Supply current- and power

Added fuse F4

A.O.

12.10.2016 A.O.

PRINCE 60 PRINCE 85

P/kW I/A P/kW I/A

9,0 10,7 12,5 15,0

VERKKO / ELECTRIC SUPPLY

3/PE AC 480V 50-60Hz

3/PE AC 480V 50-60Hz

Kytkentäkaavio

Connection diagram

Kopplingschema

Typ no PRINCE

Tilanne- T03463B3

PCE

PCE no T03463B3

PRINCE

Lehti I/1

SHEET

Rev. Muutos

Suunn.

- 1 A1 -Thermostat
- 2 S1 -Temperature ON
- 3 S2 -Safety thermostat
- 4 S3 -control tilt pan
- 5 S4,S5 -switch controls the slope



CONNECTION DIAGRAM FOR HEATING ELEMENTS
 VASTUUSIEN KYTKENTÄOHJE ERI JÄNNITEJÄRJESTELMILLÄ

3/PE 220-230V 50Hz
 K1/1-K1/5

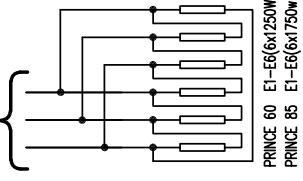

PRINCE 60 E1-E6(6x1250w 230V)
 PRINCE 85 E1-E6(6x1750w 230V)

3/PE 220-230V 50Hz

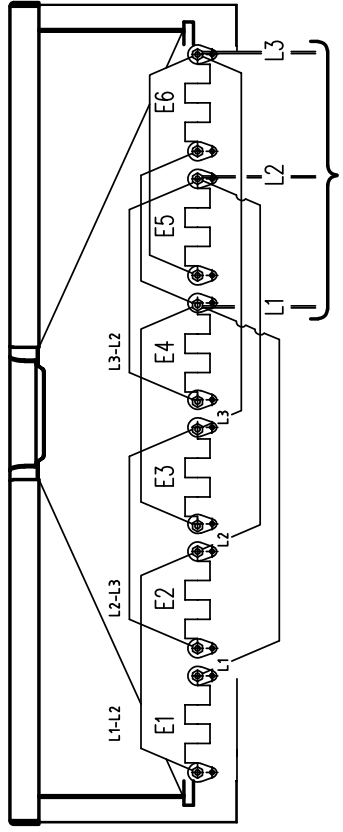

3/N/PE 380-415V 50Hz
 3/PE 380-415V 50Hz
 K1/1-K1/5

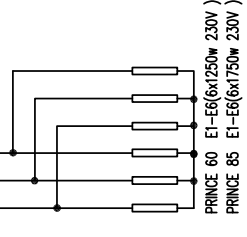

PRINCE 60 E1-E6(6x1250w 230V)
 PRINCE 85 E1-E6(6x1750w 230V)

3/N/PE 380-415V 50Hz
 3/PE 380-415V 50Hz

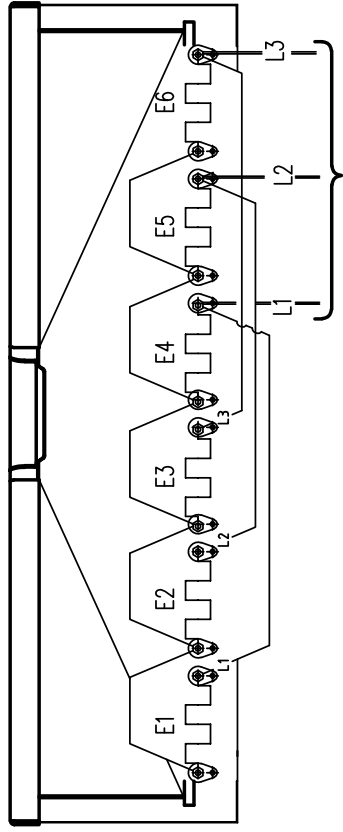

K1/1-K1/5

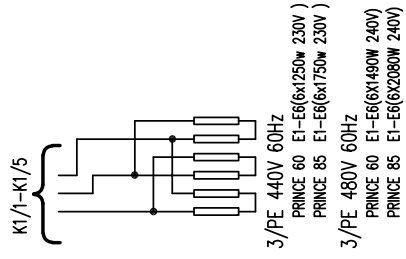

3/PE 440V 60Hz
 PRINCE 60 E1-E6(6x1250w 230V)
 PRINCE 85 E1-E6(6x1750w 230V)
 3/PE 480V 60Hz
 PRINCE 60 E1-E6(6x1490W 240V)
 PRINCE 85 E1-E6(6x2080W 240V)

3/PE 440V,480V 50-60Hz

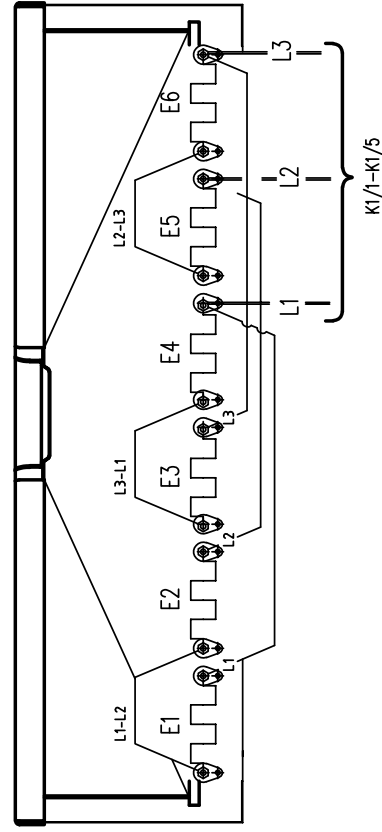

Valmistaja Tilaaja Ohje Mitt.	24.03.2007/A.0	PAISTINPANNU PRINCE 60,85 BRÄTT PAN PRINCE 60,85 STEKBORD PRINCE 60,85	Kytkentäkaavio Connection diagram Kopplingschema	3/PE AC 220-230V,50Hz 3/N/PE AC 380-415V,50Hz 3/PE AC 380-415V,50Hz 3/PE AC 440V,480V,60Hz	Tyypin Tilaajan Tilausn Pile Pile Pile Pile	T 02712B3 T 02712B3	1/1 SHEET	1/1 REV B
--	----------------	--	--	---	---	------------------------	--------------	-----------------

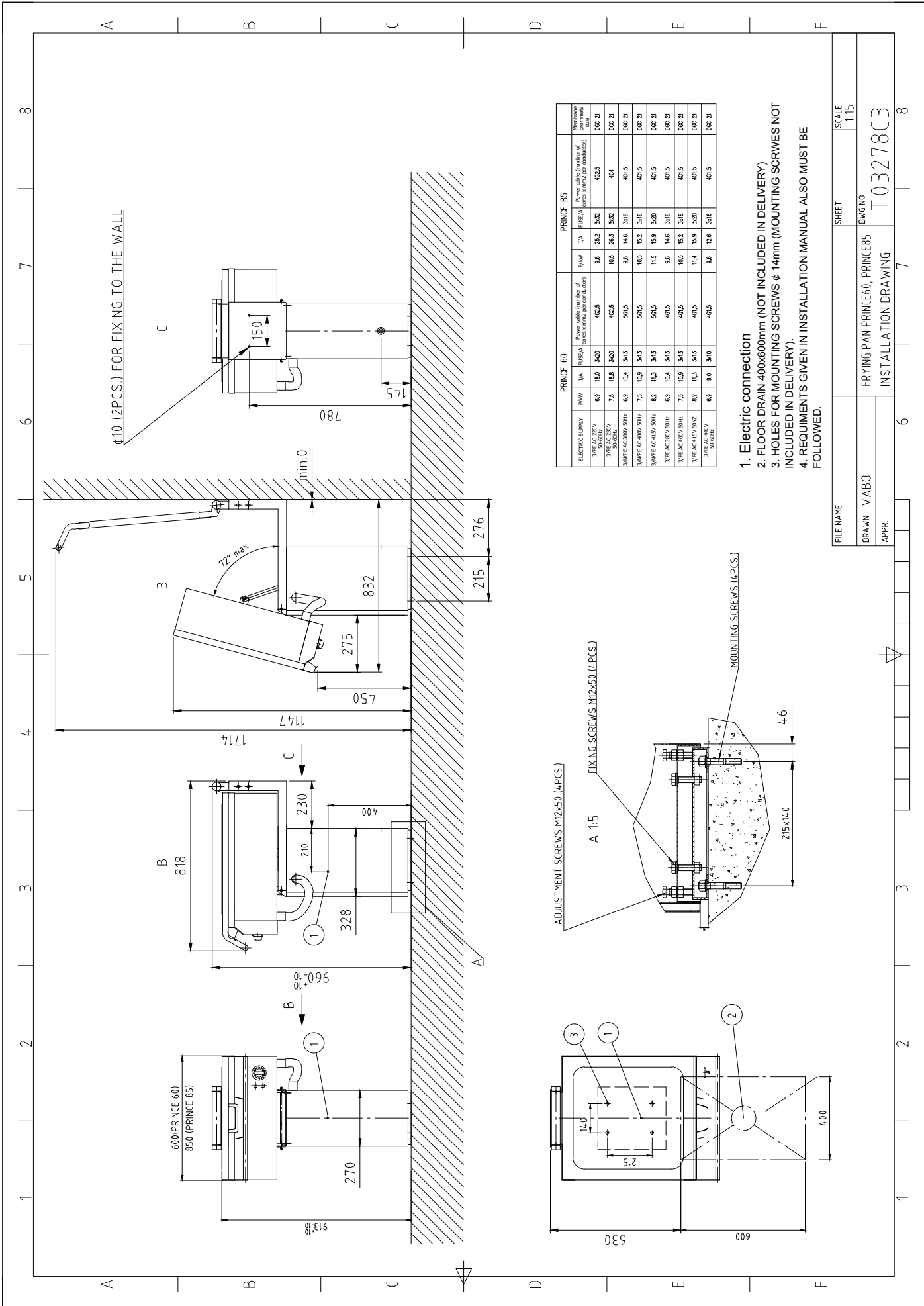

ELECTRIC SUPPLY	PRINCE 60		PRINCE 85		Minimum grammes
	P/NW	I/A	P/NW	I/A	
3/PHE AC 230V 50/60Hz	6,9	18,0	9,6	26,2	462,5
3/PHE AC 230V 50/60Hz	7,5	18,8	10,5	26,3	464
3/PHE AC 380V 50Hz	6,9	10,4	9,6	14,6	461,5
3/PHE AC 400V 50Hz	7,5	10,9	10,5	15,2	461,5
3/PHE AC 415V 50Hz	8,2	11,3	11,5	15,9	461,5
3/PHE AC 380V 50Hz	6,9	10,4	9,6	14,6	461,5
3/PHE AC 400V 50Hz	7,5	10,9	10,5	15,2	461,5
3/PHE AC 415V 50Hz	8,2	11,3	11,4	15,9	461,5
3/PHE AC 500V 50/60Hz	6,9	9,0	9,6	12,6	461,5

1. Electric connection
2. FLOOR DRAIN 400x600mm (NOT INCLUDED IN DELIVERY)
3. HOLES FOR MOUNTING SCREWS ϕ 14mm (MOUNTING SCREWS NOT INCLUDED IN DELIVERY).
4. REQUIREMENTS GIVEN IN INSTALLATION MANUAL ALSO MUST BE FOLLOWED.

FILE NAME	SHEET	SCALE
DRAWN VABO	FRYING PAN PRINCE60, PRINCE85	1:15
APPR.	INSTALLATION DRAWING	
	DWG NO	
	T03278C3	

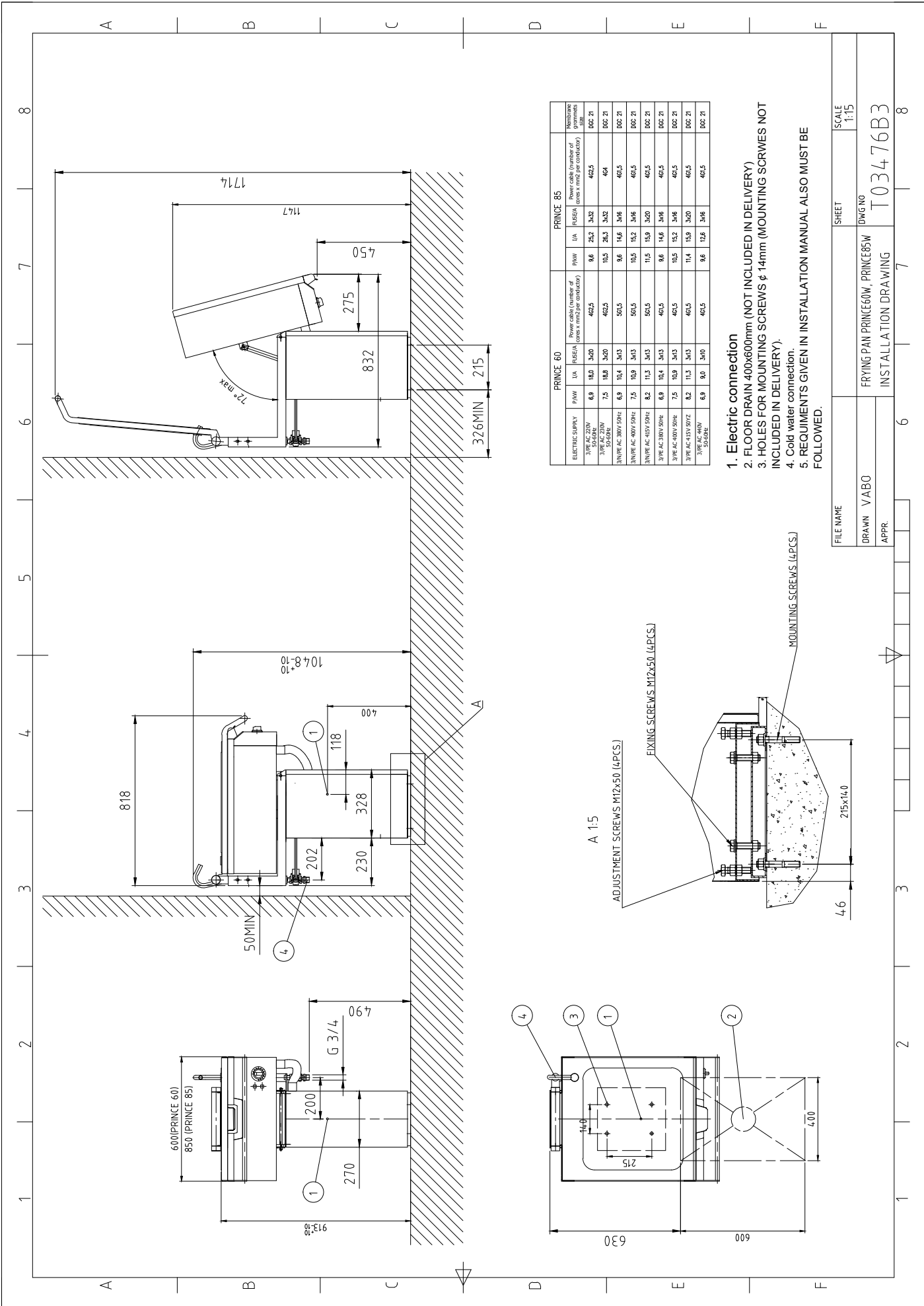

ELECTRIC SUPPLY	PRINCE 60		PRINCE 85		Number of cables (number of conductors)	Number of conductors (number of conductors)	
	P/AV	I/A	I/A	FUSE/A			
3/PH AC 230V 50/60Hz	6,9	18,0	3,20	4,62,5	4,62,5	4,62,5	0,062 ZI
3/PH AC 230V 50/60Hz	7,5	18,8	3,20	4,62,5	4,62,5	4,62,5	0,062 ZI
3/PH AC 380V 50/60Hz	8,9	18,4	3,43	5,01,5	5,01,5	5,01,5	0,062 ZI
3/PH AC 400V 50/60Hz	7,5	15,9	3,43	5,01,5	5,01,5	5,01,5	0,062 ZI
3/PH AC 415V 50/60Hz	8,2	11,3	3,43	5,01,5	5,01,5	5,01,5	0,062 ZI
3/PH AC 380V 50/60Hz	8,9	18,4	3,43	4,61,5	4,61,5	4,61,5	0,062 ZI
3/PH AC 400V 50/60Hz	7,5	15,9	3,43	4,61,5	4,61,5	4,61,5	0,062 ZI
3/PH AC 415V 50/60Hz	8,2	11,3	3,43	4,61,5	4,61,5	4,61,5	0,062 ZI
3/PH AC 400V 50/60Hz	8,9	9,0	3,40	4,61,5	4,61,5	4,61,5	0,062 ZI

1. Electric connection
2. FLOOR DRAIN 400x600mm (NOT INCLUDED IN DELIVERY)
3. HOLES FOR MOUNTING SCREWS ϕ 14mm (MOUNTING SCREWS NOT INCLUDED IN DELIVERY).
4. Cold water connection.
5. REQUIREMENTS GIVEN IN INSTALLATION MANUAL ALSO MUST BE FOLLOWED.

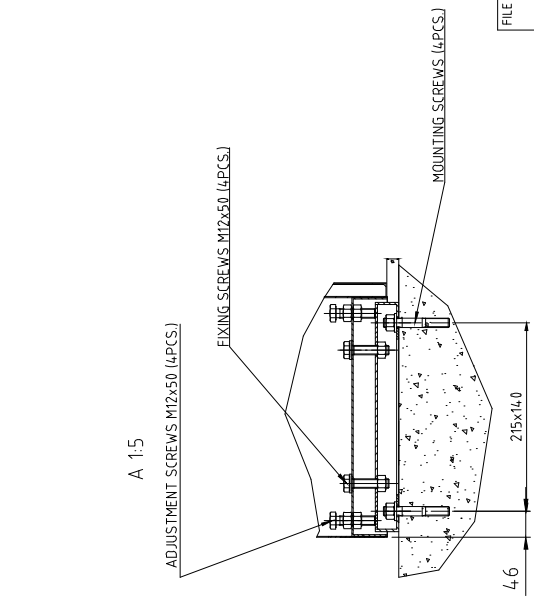

FILE NAME	SHEET	SCALE
DRAWN VABO	DWG NO	1:15
APPR.	INSTALLATION DRAWING	

FRYING PAN PRINCE60W, PRINCE85W
 T03476B3

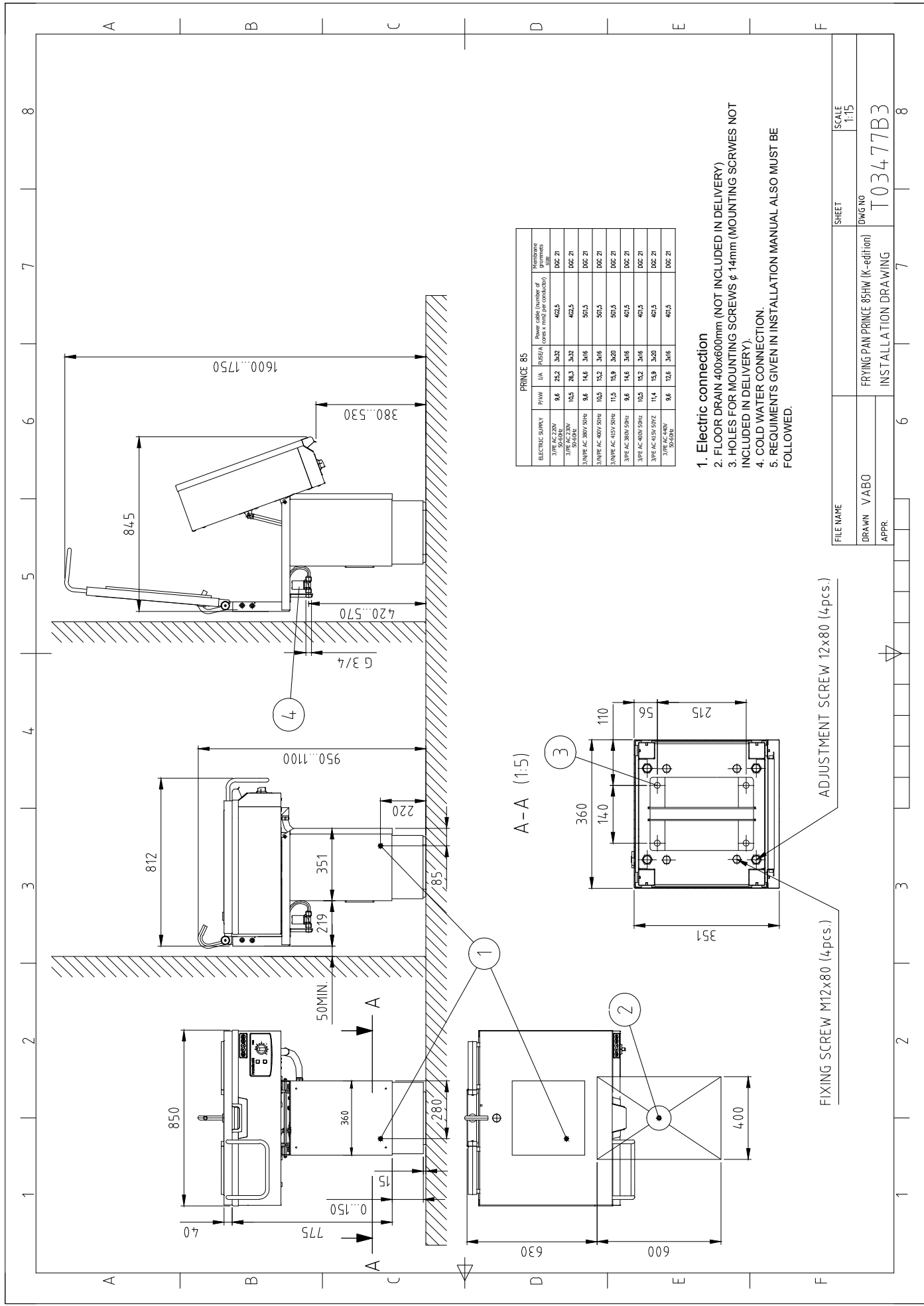

PRINCE 85					
ELECTRIC SUPPLY	P/AV	I/A	INSERIA (CONV. V. INIZ. PER CONDIZIONI)	MEMBRANE (grammage)	
3/PH AC 230V 50/60Hz	9,6	26,2	3,62	462,5	D0C 21
3/PH AC 230V 50/60Hz	10,5	26,3	3,62	462,5	D0C 21
3/PH AC 380V 50Hz	9,6	14,6	3,16	501,5	D0C 21
3/PH AC 400V 50Hz	10,5	15,2	3,16	501,5	D0C 21
3/PH AC 415V 50Hz	11,5	15,9	3,60	501,5	D0C 21
3/PH AC 480V 50Hz	9,6	14,6	3,16	461,5	D0C 21
3/PH AC 480V 50Hz	10,5	15,2	3,16	461,5	D0C 21
3/PH AC 415V 50Hz	11,4	15,9	3,60	461,5	D0C 21
3/PH AC 480V 50Hz	9,6	12,6	3,16	461,5	D0C 21

1. Electric connection
2. FLOOR DRAIN 400x600mm (NOT INCLUDED IN DELIVERY)
3. HOLES FOR MOUNTING SCREWS ϕ 14mm (MOUNTING SCREWS NOT INCLUDED IN DELIVERY).
4. COLD WATER CONNECTION.
5. REQUIREMENTS GIVEN IN INSTALLATION MANUAL ALSO MUST BE FOLLOWED.

FILE NAME: _____ SHEET: _____ SCALE: 1:15

DRAWN: VABO DRAWING NO: T03477B3

APPR: _____ INSTALLATION DRAWING

ADJUSTMENT SCREW 12x80 (4pcs.)

FIXING SCREW M12x80 (4pcs.)

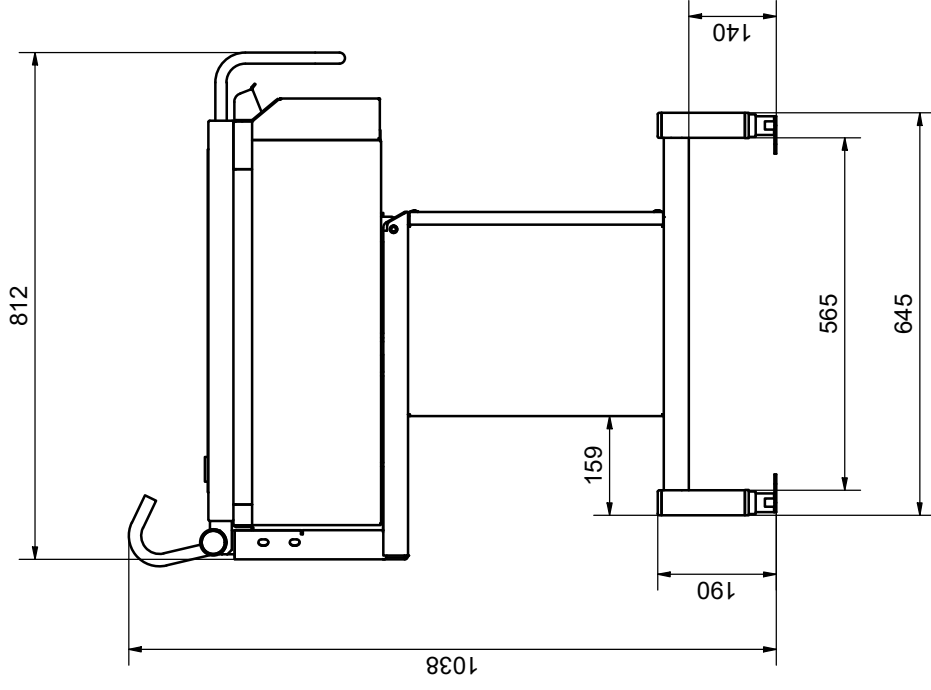
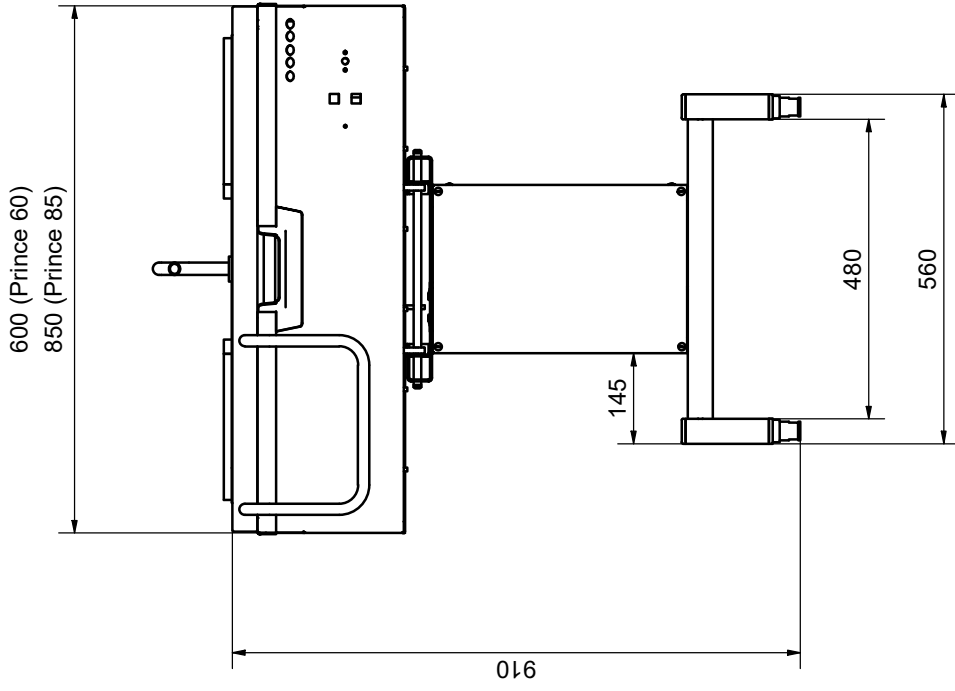

Tekniset mitat
PRINCE FS
Technical drawing



Suhte	1:8	Piirno	
Suunn.	16.6.2025	teirimi	
Koodi	Installation drawing		
Talennettu	16.6.2025	12.10	
Talorimatomaat mitat	ISO 2768-mK		

Työno.	Rivi
Positio	Käyttön.

Technical specifications table

Item	Model	Type	Voltage	Specification
Dimensions WxDxH		60		600x818x960 mm*
Dimensions WxDxH		85		850x818x960 mm*
Package dimensions WxDxH		60		720x920x1200 mm
Package dimensions WxDxH		85		970x920x1200 mm
Frying zones		60,85		1pc
Heigh of frying zone sides, shallow pan	L	60		90mm
Heigh of frying zone sides, deep pan	D	60		130mm
Heigh of frying zone sides, shallow pan	L	85		90mm
Heigh of frying zone sides, deep pan	D	85		180mm
Frying surface WxD		60		540x530 mm
Frying surface WxD		85		790x530 mm
Geometrical volume of the pan, shallow pan	L	60		25L
Geometrical volume of the pan, deep pan	D	60		37L
Geometrical volume of the pan, shallow pan	L	85		37L
Geometrical volume of the pan, deep pan	D	85		75L
Temperature setting range				50°C...250°C
Weigh without package		60		111 kg
Weigh without package		85		134kg
Weigh with package		60		131kg
Weigh with package		85		154kg
Material of frying surface				Steel or stainless steel (on request)
Material of frying zone sides				Stainless steel
Outer surface				Stainless steel
Power		60	C,I,J,M	6,9kW
Power		60	A,H,K	7,5kW
Power		60	G,L	8,2kW
Power		85	C,I,J,M	9,6kW
Power		85	A,H,K	10,5kW
Power		85	G,L	11,4kW
Operating conditions				Normal commercial kitchens conditions, temperature above 0°C

* Dimensions for basic version. Refer to the installation drawings to view dimensions with H and W options.

METOS OY AB
LOMAKE LT30024
Rev. PED 5.8 31.3.2020

EU-VAATIMUSTENMUKAISUUSVAKUUTUS
EU-FÖRSÄKRAN OM ÖVERENSSTÄMMELSE
EU DECLARATION OF CONFORMITY

Valmistajan nimi / Tillverkarens namn / Manufacturer's name
METOS OY AB

Osoite / Adress / Address
04220 KERAVA
FINLAND

Vakuuttaa, että seuraava tuote / Försäkrar att följande produkt / Declare that the following product

Nimi, tyyppi tai malli / Namn, typ eller modell / Name, type or model

Paistinpannu / Stekbord / Bratt Pann

METOS Futura HD

Mallit / Modeller / Models : 100, 150, 300 With accessories: hose reel spray Unit, remote control

METOS Futura E/M

Mallit / Modeller / Models : 85, 85L, 85D, 110, 110L, 110D With accessories: height adjustment, water tap, stainless steel bottom, manual tilting, wall installation

METOS Prince

Mallit / Modeller / Models : 60, 80 With accessories: height adjustment, water tap, stainless steel bottom

on seuraavien direktiivien asiaankuuluvien säännösten mukainen / överensstämmer med tillämpliga bestämmelser i följande direktiv / is in conformity with the relevant provisions of the following directives

MD 2006/42/EC, LVD 2014/35/EU, EMC 2014/30/EU, RoHS 2011/65/EC, WEEE 2012/19/EU

ja lisäksi vakuuttaa, että seuraavia yhdenmukaistettuja standardeja (tai niiden osia/kohtia) on sovellettu / och försäkrar dessutom att följande harmoniserade standarder (eller delar/paragrafer) har använts / and furthermore declares that the following harmonised standards (or parts/clauses) have been used

EN ISO 12100:2010, EN ISO 13857:2019, EN 61000-6-1:2019, EN 61000-6-3,
EN 60204-1:2018

ja lisäksi vakuuttaa, että seuraavia muita standardeja (tai niiden osia/kohtia) on sovellettu / och försäkrar dessutom att följande andra standarder (eller delar/paragrafer) har använts / and furthermore we declare that the following other standards (or parts/clauses) have been used

EN 60335-1:2020, EN 60335-2-39:2012, EN 60335-2-36:2017, EN 60335-2-42

Alla mainittu henkilö on valtuutettu kokoamaan teknisen tiedoston / Nedan nämnda person är bemyndigad att sammanställa den tekniska dokumentfilen / The person mentioned below is authorized to compile the technical file

Risto Koskelainen

Metos Oy Ab, Ahjonkaarre, 04220 Kerava, Finland

Tämä vaatimustenmukaisuusvakuutus on annettu valmistajan yksinomaisella vastuulla. Edellä kuvattu vakuutuksen kohde on unionin asiaankuuluvan yhdenmukaistamislainsäädännön vaatimusten mukainen.

Denna EU-försäkran om överensstämmelse utfärdas på tillverkarens eget ansvar. Föremålet för försäkran ovan överensstämmer med den relevanta unionslagstiftningen om harmonisering.

This declaration of conformity is issued under the sole responsibility of the manufacturer. The object of the declaration described above is in conformity with the relevant Union harmonisation legislation

Antopaikka ja päivä / Utfärdad på ort och datum / Place and date of issue

KERAVA

30.11.2021

Vakuutuksen antajan nimi ja asema / Namn och befattning av personen som försäkrar / Name and title of declaring person

Hannu Ahola – Director of Business Unit

Marko Immonen – R&D Manager

Manufacturer's name METOS OY AB
Address 04220 KERAVA FINLAND

Declare that the following product

Name, type or model Bratt Pann METOS Futura HD Models : 100, 150, 300 With accessories: hose reel spray Unit, remote control METOS Futura E/M Models : 85, 85L, 85D, 110, 110L, 110D With accessories: height adjustment, water tap, stainless steel bottom, manual tilting, wall installation METOS Prince Models : 60, 80 With accessories: height adjustment, water tap, stainless steel bottom
--

is in conformity with the essential requirements and other relevant requirements of the UK legislation. The products are in conformity with the relevant UK legislation

Electrical Equipment (Safety) Regulations 2016, Electromagnetic Compatibility (EMC) Regulations 2016, Machinery (Safety) Regulations 2008: Great Britain, The Restriction of the Use of Certain Hazardous Substances in Electrical and Electronic Equipment Regulations 2012, Regulations: Waste Electrical and Electronic Equipment (WEEE)
--

furthermore declares that the following harmonized standards (or parts/clauses) have been used

BS EN ISO 12100:2010, BS EN ISO 13857:2008, BS EN IEC 61000-6-1:2019, BS EN IEC 61000-6-3:2007, BS EN 60204-1:2018

and furthermore we declare that the following other standards (or parts/clauses) have been used



BS EN 60335-1:2012+A15:2021, BS EN 60335-2-42, BS EN 60335-2-36
--

The person mentioned below is authorized to compile the technical file

Otto Miettinen Metos Oy Ab, Ahjonkaarre, 04220 Kerava, Finland

This declaration of conformity is issued under the sole responsibility of the manufacturer. The object of the declaration described above is in conformity with the relevant UK legislation

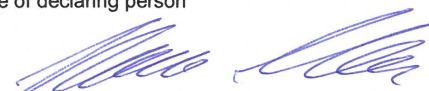
Place and date of issue KERAVA 31.12.2022

Name and title of declaring person  Hannu Ahola – Director of Business Unit	 Risto Koskelainen – R&D Manager
---	--



Metos Oy Ab

Ahjonkaarre, 04220 Kerava

Puh. +358 204 3913

Sähköposti: metos.finland@metos.com

www.metos.com